



**UNIVERSIDADE FEDERAL DO CEARÁ**  
**CENTRO DE CIÊNCIAS**  
**DEPARTAMENTO DE COMPUTAÇÃO**  
**PROGRAMA DE PÓS-GRADUAÇÃO EM CIÊNCIAS DA COMPUTAÇÃO**

**JONAS COSTA FERREIRA DA SILVA**

**STRUCTURAL AND COMPLEXITY STUDIES IN INVERSIONS AND COLOURING**  
**HEURISTICS OF (ORIENTED) GRAPHS**

**FORTALEZA**

**2023**

JONAS COSTA FERREIRA DA SILVA

STRUCTURAL AND COMPLEXITY STUDIES IN INVERSIONS AND COLOURING  
HEURISTICS OF (ORIENTED) GRAPHS

PhD Thesis submitted to the *Programa de Pós-graduação em Ciências da Computação* of the Universidade Federal do Ceará, as a partial requirement for obtaining the title of *Doutor em Ciência da Computação*. Concentration Area: Computer Science

Advisor: Profa. Dra. Ana Karolinna Maia de Oliveira

Co-advisor: Profa. Dra. Cláudia Linhares Sales

FORTALEZA

2023

Dados Internacionais de Catalogação na Publicação  
Universidade Federal do Ceará  
Sistema de Bibliotecas  
Gerada automaticamente pelo módulo Catalog, mediante os dados fornecidos pelo(a) autor(a)

---

- S58s Silva, Jonas Costa Ferreira da.  
Structural and complexity studies in inversions and colouring heuristics of (oriented) graphs / Jonas Costa Ferreira da Silva. – 2023.  
127 f. : il. color.
- Tese (doutorado) – Universidade Federal do Ceará, Centro de Ciências, Programa de Pós-Graduação em Ciência da Computação, Fortaleza, 2023.  
Orientação: Profa. Dra. Ana Karolinna Maia de Oliveira.  
Coorientação: Profa. Dra. Cláudia Linhares Sales.
1. Inversion number. 2. B-Grundy number. 3. Z-number. 4. Feedback vertex set. 5. Colouring heuristics.  
I. Título.

CDD 005

---

JONAS COSTA FERREIRA DA SILVA

STRUCTURAL AND COMPLEXITY STUDIES IN INVERSIONS AND COLOURING  
HEURISTICS OF (ORIENTED) GRAPHS

PhD Thesis submitted to the *Programa de Pós-graduação em Ciências da Computação* of the Universidade Federal do Ceará, as a partial requirement for obtaining the title of *Doutor em Ciência da Computação*.  
Concentration Area: Computer Science

Approved on: 25/05/2023

EXAMINATION BOARD

---

Profa. Dra. Ana Karolinna Maia de  
Oliveira (Advisor)

Universidade Federal do Ceará  
(UFC)

---

Profa. Dra. Cláudia Linhares Sales  
(Co-advisor)

Universidade Federal do Ceará  
(UFC)

---

Profa. Dra. Celina Miraglia Herrera de  
Figueiredo

Universidade Federal do Rio de Janeiro  
(UFRJ)

---

Prof. Dr. Frédéric Havet

Universtité Côte D'azur  
(UCA)

---

Prof. Dr. Júlio César Silva Araújo

Universidade Federal do Ceará  
(UFC)

---

Prof. Dr. Thiago Braga Marcilon

Universidade Federal do Cariri  
(UFCA)

## ACKNOWLEDGEMENTS

Firstly, to God, the Begin and the Reason for all things. To my parents, João Mendonça and Cássia, and my sisters, Jocássia and Jéssica, for all the love and support they give me. To my advisor, Karol, for her dedication as a mentor but also for her friendship, always wanting the best for me. I feel a great satisfaction for being her first master's and doctoral student. To my co-supervisor, Cláudia, for all the help she provided and for not letting my hair look ugly. To the members of the examining board for the time dedicated to reading this thesis and for their valuable suggestions and comments. To the teachers, Júlio, Fred, Nico, Jørgen and Ignasi for their collaboration during my stay in France. To the ParGO teachers, for all their collaboration and for making this group such a pleasant environment to work in. To my colleagues Raul and Cláudio who worked with me during my PhD. To the other ParGO colleagues, especially the laboratory guys, Leonardo, Emanuel, Beatriz and Davi for their friendship and help with latex, English, etc. To my lovely girlfriend, Noémie, for being so close despite being so far away, always listening to my complaints and helping me to move forward. To my friends and especially Lucas, Victor, and Jeferson for their support and for watching my defense even without understanding a word. To my brothers from the Shalom Catholic Community for sustaining me with their prayers. To all the teachers I've ever had.

This study was financed in part by the Coordenação de Aperfeiçoamento de Pessoal de Nível Superior - Brasil (CAPES) - Finance Code 001.

\*\*\*

Em primeiro lugar, a Deus, Princípio e Razão de todas as coisas. Aos meus pais, João Mendonça e Cássia, e às minhas irmãs, Jocássia e Jéssica, por todo amor e apoio que me dedicam. À minha orientadora, Karol, por sua dedicação como orientadora e sobretudo por sua amizade, querendo sempre o melhor para mim. Sinto uma imensa satisfação por ter sido seu primeiro aluno de mestrado e doutorado. À minha coorientadora, Cláudia, por todo auxílio prestado e por não deixar meu cabelo ficar feio. Aos membros da banca examinadora pelo tempo dedicado à leitura desta tese e pelas valiosas sugestões. Aos professores, Júlio, Fred, Nico, Jørgen e Ignasi pela colaboração durante a minha estadia na França. Aos professores do ParGO, por toda colaboração e por tornarem esse grupo um ambiente tão agradável de se trabalhar. Aos meus colegas Raul e Cláudio que trabalharam comigo durante o doutorado. Aos demais colegas do ParGO, em especial o pessoal do laboratório, Leonardo, Emanuel, Beatriz e

Davi pela amizade e ajuda com latex, inglês etc. À minha querida namorada, Noémie, por se fazer tão perto mesmo estando tão longe, sempre ouvindo minhas queixas e me ajudando a seguir em frente. Aos meus amigos e em especial, Lucas, Victor e Jeferson pelo apoio e por terem assistido a minha defesa mesmo sem entender uma palavra. Aos meus irmãos da Comunidade Católica Shalom por me sustentarem com suas orações. A todos professores que eu já tive.

O presente trabalho foi realizado com apoio da Coordenação de Aperfeiçoamento de Pessoal de Nível Superior - Brasil (CAPES) - Código de Financiamento 001.

## RESUMO

Esta tese está dividida em duas partes. A primeira trata do número de inversão de grafos orientados. Seja  $D$  um grafo orientado. A *inversão* de um conjunto de vértices  $X \subseteq V(D)$  em  $D$  consiste na reversão da orientação de todos os arcos com ambas as extremidades em  $X$ . O *número de inversão* de  $D$ , denotado por  $\text{inv}(D)$ , é dado pelo menor número de inversões que são necessárias para que  $D$  se torne acíclico. Nós estudamos a relação entre o número de inversão e alguns parâmetros relacionados aos problemas de FEEDBACK ARC SET e FEEDBACK VERTEX SET. Denotamos por  $\tau(D)$  (resp.  $\tau'(D)$ ) o tamanho mínimo de um conjunto de vértices (resp. arcos) cuja remoção torna o digrafo acíclico, isto é, o tamanho do menor *feedback vertex set* (resp. *feedback arc set*). Denotamos por  $\nu(D)$  o tamanho do maior conjunto de ciclos disjuntos de  $D$ . Nós mostramos que  $\text{inv}(D) \leq \tau'(D)$ ,  $\text{inv}(D) \leq 2\tau(D)$ , que existe uma função  $g$  tal que  $\text{inv}(D) \leq g(\nu(D))$  e que  $g(1) \leq 4$ .

O *dijoin* de dois grafos orientados  $L$  e  $R$ , denotado por  $L \rightarrow R$ , é dado pela união disjunta de destes acrescida de todos os possíveis arcos dos vértices de  $L$  para os de  $R$ . Nós conjecturamos que para quaisquer grafos orientados  $L$  e  $R$ ,  $\text{inv}(L \rightarrow R) = \text{inv}(L) + \text{inv}(R)$ . Isso implicaria que as duas primeiras desigualdades são apertadas. Nós provamos essa conjectura para quando  $\text{inv}(L) \leq 1$  e  $\text{inv}(R) \leq 2$  e quando  $\text{inv}(L) = \text{inv}(R) = 2$  e ambos  $L$  e  $R$  são fortemente conexos. Consideramos também a complexidade de decidir se  $\text{inv}(D) \leq k$  para um dado grafo orientado  $D$ . Nós mostramos que esse problema é NP-completo para  $k = 1$  e  $k = 2$  o que, juntamente com a conjectura mencionada acima, implicaria a NP-completude desse problema para qualquer valor de  $k$ . Isso contrasta com um outro resultado de Belkhechine et al. (BELKHECHINE *et al.*, 2010) que afirma que, para um dado torneio  $T$ , é possível decidir em tempo polinomial se  $\text{inv}(T) \leq k$ . A segunda parte desta tese aborda colorações b-gulosas e z-colorações. Um *b-vértice* em uma coloração própria é um vértice que tem pelo menos um vizinho de todas as demais cores. Se em uma coloração própria há um b-vértice de cada cor, então dizemos que esta é uma *b-coloração*. Uma coloração própria é *gulosa* se todo vértice é guloso, isto é, adjacente a pelo menos um vértice de cada cor menor que a sua. Por sua vez, *coloração b-gulosa* é uma coloração que é, ao mesmo tempo, uma b-coloração e uma coloração gulosa. Uma z-coloração é uma coloração b-gulosa que possui um b-vértice de cor máxima que é adjacente a pelo menos um b-vértice de cada uma das demais cores. O *número b-cromático de Grundy* (resp. número z-cromático) de um grafo é o maior número de cores possível em uma coloração b-gulosa (resp. z-coloração) deste grafo. Na segunda parte nós estudamos esses dois parâmetros. Nós mostramos que eles não

são monotônicos e que a distância entre eles e o mínimo entre o número de Grundy e o número b-cromático pode ser arbitrariamente grande. Além disso, provamos que é NP-difícil obter cada um desses parâmetros. Por outro lado, descrevemos um algoritmo polinomial que decide se um dado grafo  $k$ -regular tem número b-cromático de Grundy (resp. z-cromático) igual a  $k + 1$ . Também provamos que, exceto pelo grafo de Petersen, todo grafo cúbico sem  $C_4$  induzido tem número b-cromático de Grundy e número z-cromático igual a 4. Por fim, apresentamos um resumo de outros tópicos envolvendo fluxos que foram estudados durante este doutorado.

**Palavras-chave:** feedback vertex set; feedback arc set; inversões; torneios; coloração de grafos; algoritmos de coloração; coloração gulosa; b-coloração.



## ABSTRACT

This thesis is divided in two parts, where the first one concerns the inversion number of oriented graphs. Let  $D$  be an oriented graph. The *inversion* of a set  $X$  of vertices in  $D$  consists in reversing the direction of all arcs with both extremities in  $X$ . The *inversion number* of  $D$ , denoted by  $\text{inv}(D)$ , is the minimum number of inversions needed to make  $D$  acyclic. We studied the relation between the inversion number and other parameters related to problems of FEEDBACK ARC SET and FEEDBACK VERTEX SET. We denote by  $\tau(D)$  (resp.  $\tau'(D)$ ), the size of a minimum set of vertices (resp. arcs) whose removal makes  $D$  acyclic, that is, the minimum size of a *feedback vertex set* (resp. *feedback arc set*). For a digraph  $D$ , we denote by  $\nu(D)$ , the maximum size of a disjoint set of cycles of  $D$ . We show that  $\text{inv}(D) \leq \tau'(D)$ ,  $\text{inv}(D) \leq 2\tau(D)$  and that there exists a function  $g$  such that  $\text{inv}(D) \leq g(\nu(D))$  and  $g(1) \leq 4$ . For two oriented graphs  $L$  and  $R$ , the *dijoin* from  $L$  to  $R$ , denoted by  $L \rightarrow R$ , is the oriented graph formed by the disjoint union of  $L$  and  $R$  along with the set of all possible arcs from the vertices of  $L$  to those in  $R$ . We conjecture that  $\text{inv}(L \rightarrow R) = \text{inv}(L) + \text{inv}(R)$ , for any two oriented graphs  $L$  and  $R$ . This would imply that the first two inequalities are tight. We prove this conjecture when  $\text{inv}(L) \leq 1$  and  $\text{inv}(R) \leq 2$  and when  $\text{inv}(L) = \text{inv}(R) = 2$  and  $L$  and  $R$  are strongly connected.

We then consider the complexity of deciding whether  $\text{inv}(D) \leq k$  for a given oriented graph  $D$ . We show that it is NP-complete for  $k = 1$ , which together with the above conjecture would imply that it is NP-complete for every  $k$ . This contrasts with a result of Belkhechine et al. (BELKHECHINE *et al.*, 2010) which states that deciding whether  $\text{inv}(T) \leq k$  for a given tournament  $T$  is polynomial-time solvable.

The second part of this work is about  $b$ -greedy colourings and  $z$ -colourings. A  $b$ -vertex in a proper colouring is a vertex that has at least one neighbour of every other colour. If in a proper colouring there is a  $b$ -vertex of each colour, we say that it is a  $b$ -colouring. A greedy colouring is a proper colouring in which every vertex is greedy, that is, it has at least one neighbour of every colour smaller than its own. In its turn, a  $b$ -greedy colouring is a proper colouring which is both a  $b$ -colouring and a greedy colouring. A  $z$ -colouring is a  $b$ -greedy colouring such that a  $b$ -vertex of the largest colour is adjacent to a  $b$ -vertex of every other colour. The  $b$ -Grundy number (resp.  $z$ -number) of a graph is the maximum number of colours in a  $b$ -greedy colouring (resp.  $z$ -colouring) of it. In this part, we study those two parameters. We show that they are not monotone and that they can be arbitrarily smaller than the minimum of the Grundy number and the  $b$ -chromatic number. We prove that it is NP-hard to compute each of those parameters.

However, we describe a polynomial-time algorithm that decides whether a given  $k$ -regular graph has b-Grundy number (resp. z-number) equal to  $k + 1$ . We also prove that, except for the Petersen graph, every cubic graph with no induced 4-cycle has b-Grundy number and z-number exactly 4. Finally, we present a summary of other topics involving flows studied during this PhD.

**Keywords:** feedback vertex set; feedback arc set; inversion; tournament; graph colouring; colouring algorithms; greedy colourings; b-colourings.

## LIST OF FIGURES

Figure 1	– An example of a graph $G_1$ of order 4. . . . .	22
Figure 2	– Examples of subgraphs of the graph $G_2$ . (a) The graph $G_2$ and $G_2[\{u_3, u_4, u_5, u_6\}]$ (highlighted). (b) $G_2 - u_2u_3$ . (c) $G_2 - u_4$ . . . . .	23
Figure 3	– Two complete bipartite graphs: (a) $K_{3,3}$ and (b) $K_{1,4}$ , the star of order 5. . . . .	24
Figure 4	– The digraph $D_4$ . . . . .	26
Figure 5	– A directed path and a directed cycle. . . . .	26
Figure 6	– A $K_5$ (a) and an orientation of $K_5$ (b). . . . .	27
Figure 7	– A directed $\vec{P}_4$ (a), a directed $\vec{P}_2$ (b), and the lexicographic product $\vec{P}_4[\vec{P}_2]$ (c). . . . .	27
Figure 8	– A digraph $D$ on the left and $\text{Inv}(D; \{a, b, e\})$ on the right. The highlighted subdigraph on the left stands for $D[\{a, b, e\}]$ . . . . .	28
Figure 9	– Example of inversions of a tournament with inversion number two. . . . .	30
Figure 10	– A tournament $Q_5$ . . . . .	33
Figure 11	– Example of oriented graph. . . . .	35
Figure 12	– Representation of the lexicographic product of $TT_n$ by $\vec{C}_3$ . The arcs in bold from one circle to another represent all possible arcs from the vertices inside the first to the ones inside the second. . . . .	37
Figure 13	– Representation of $T_3$ , where inversion number is 1 but cycle packing number is 3. . . . .	39
Figure 14	– The 2-inversion-critical tournaments (Source: (BANG-JENSEN <i>et al.</i> , 2022)). . . . .	42
Figure 15	– The oriented graph $D^*$ (Source: (BANG-JENSEN <i>et al.</i> , 2022)). . . . .	44
Figure 16	– The $z$ -augmentation $\sigma(z, D)$ of a digraph $D$ (Source: (BANG-JENSEN <i>et al.</i> , 2022)). . . . .	55
Figure 17	– The digraph $H_2$ (Source: (BANG-JENSEN <i>et al.</i> , 2022)). . . . .	56
Figure 18	– (a): the digraph $D_7$ ; (b): the digraph $D'_7$ obtained from $D_7$ by inverting the set $\{y, y_2, y_4, y_6\}$ ; (c): the acyclic digraph $D''_7$ obtained from $D'_7$ by inverting the set $\{y_2, y_3, y_5, y_6\}$ . (Source: (BANG-JENSEN <i>et al.</i> , 2022)). . . . .	59
Figure 19	– The digraphs from $\mathcal{K}$ . The arrow in the grey area symbolizing the acyclic (plane) digraph $K_H$ indicates that $z_0, w_0$ are its sources and $z_1, w_1$ are its sinks. (This figure is a courtesy of (BANG-JENSEN; KRIESELL, 2011)). . . . .	59
Figure 20	– The digraphs from $\mathcal{H}$ . (This figure is a courtesy of (BANG-JENSEN; KRIESELL, 2011)). . . . .	60

Figure 21 – The oriented graph $J$ (Source: (BANG-JENSEN <i>et al.</i> , 2022)). . . . .	62
Figure 22 – The variable gadget $K_i$ (Source: (BANG-JENSEN <i>et al.</i> , 2022)). . . . .	62
Figure 23 – Indicating how to merge the two orderings of $A$ and $B$ (Source: (BANG-JENSEN <i>et al.</i> , 2022)). . . . .	68
Figure 24 – A 4-colouring and a 3-colouring of a graph. . . . .	70
Figure 25 – Two possible outputs of the greedy algorithm. . . . .	71
Figure 26 – Greedy improvement example. (a) A colouring $\phi$ of a graph. (b) The colouring $\phi'$ obtained from a greedy improvement of $\phi$ . (c) The colouring obtained from a greedy improvement of $\phi'$ . . . . .	72
Figure 27 – Example of a b-improvement. In (a), there is a colouring with no b-vertex of colour 1, so it is possible to perform a b-improvement moving the vertices from $S_1$ to other classes. In (b), there is one of the two possibilities of b-improvement that can be performed from the colouring shown in (a). . . . .	73
Figure 28 – A 4-b-colouring of a $4S_4$ . . . . .	74
Figure 29 – Three different types of colourings of the same graph: greedy colouring (a), b-colouring (b), b-greedy colouring (c). Observe that to obtain the greedy colourings of (a) and (c), the vertices were not processed in alphabetic order. . . . .	75
Figure 30 – Illustration of the application of Theorem’s 4.1.4 techniques to convert a b-greedy colouring (a) into a z-colouring (d). . . . .	78
Figure 31 – The tree $T_b$ (a) and a 4-b-greedy colouring for $2T_b$ (b). The vertices $a, b, c$ and $d$ are b-vertices. . . . .	81
Figure 32 – The graphs $M_4$ (a) and $N_4$ (b) with a greedy 4-colouring. . . . .	81
Figure 33 – The graph $G$ . . . . .	85
Figure 34 – The graph $L_5$ . . . . .	87
Figure 35 – The four cubic graphs with b-chromatic number less than 4. . . . .	90
Figure 36 – The graphs $I_1, I_2$ , and $I_3$ made of two intersecting 6-cycles. . . . .	92
Figure 37 – The configuration $J_1$ and its 4-z-colouring. Dotted lines represent non-edges. Some edges may be missing. . . . .	92
Figure 38 – The configurations $J'_1$ and $J''_1$ and their partial 4-z-colourings. Dotted lines represent non-edges. Some edges may be missing. . . . .	93
Figure 39 – The configuration $J_2$ and its 4-z-colouring. Dotted lines represent non-edges. Some edges may be missing. . . . .	94

Figure 40 – The configuration $J_3$ and its 4-z-colouring. Dotted lines represent non-edges. Some edges may be missing. . . . .	95
Figure 41 – The configuration $J_4$ and its 4-z-colouring. Dotted lines represent non-edges. Some edges may be missing. . . . .	95
Figure 42 – The graphs $I_5$ and $I_6$ made of two intersecting 5-cycles. . . . .	97
Figure 43 – The configuration $J_5^1$ and its 4-z-colouring. Dotted lines represent non-edges. Some edges may be missing. . . . .	97
Figure 44 – The configuration $J_5^2$ and its 4-z-colouring. Dotted lines represent non-edges. Some edges may be missing. . . . .	98
Figure 45 – The configuration $J_5^3$ and its 4-z-colouring. Dotted lines represent non-edges.	98
Figure 46 – The configuration $J_5^4$ and its partial 4-z-colouring. Dotted lines represent non-edges. Some edges may be missing. . . . .	99
Figure 47 – The configuration $J_6^1$ and its partial 4-z-colouring. Dotted lines represent non-edges. Some edges may be missing. . . . .	99
Figure 48 – The configuration $J_6^2$ and its partial 4-z-colouring. Dotted lines represent non-edges. Some edges may be missing. . . . .	100
Figure 49 – The configuration $J_7^1$ and its partial 4-z-colouring. Dotted lines represent non-edges. Some edges may be missing. . . . .	100
Figure 50 – The configuration $J_7^2$ and its partial 4-z-colouring. Dotted lines represent non-edges. Some edges may be missing. . . . .	101
Figure 51 – The graph $D$ and the configuration $D^1$ and its 4-z-colouring. . . . .	102
Figure 52 – The graph $H_1$ . . . . .	102
Figure 53 – The configurations $H_1^1$ and $H_1^1$ and their 4-z-colourings. . . . .	102
Figure 54 – Configuration $H_1^3$ . . . . .	103
Figure 55 – Configuration $H_1^4$ . . . . .	103
Figure 56 – The $k$ -binomial trees for $k \in [4]$ . The black vertices are their roots. . . . .	107
Figure 57 – Representation of $F_k^i$ and $T_k$ . The black vertices represent the leaves of $F_k^i$ and $F_k^{i+1}$ that are identified, for $i \in [k-3]$ . . . . .	108
Figure 58 – The trees $R_3$ (a) and $R_4$ (b) with a 3-z-colouring and a 4-z-colouring, respec- tively. (Adapted from (ZAKER, 2020).) . . . . .	110

## LIST OF TABLES

Table 1 – The 20 first numbers of sequence A000568. . . . .	34
Table 2 – The values of $\text{inv}(n)$ , for $n \leq 8$ . . . . .	34
Table 3 – The number of tournaments with inversion number $k$ in each set $\mathcal{T}^i$ , for every $k \leq 3$ and $3 \leq i \leq 8$ . . . . .	35

## CONTENTS

1	INTRODUCTION . . . . .	15
2	BASIC CONCEPTS . . . . .	22
2.1	Graphs . . . . .	22
2.1.1	<i>Special classes of graphs</i> . . . . .	24
2.2	Directed graphs . . . . .	25
2.2.1	<i>Special classes of digraphs</i> . . . . .	26
3	INVERSIONS OF ORIENTED GRAPHS . . . . .	28
3.1	Decycling family and inversion number of oriented graphs . . . . .	29
3.2	Properties and bounds of the inversion number . . . . .	30
3.2.1	<i>Maximum inversion number of an oriented graph of order <math>n</math></i> . . . . .	32
3.2.1.1	<i>Computing <math>\text{inv}(n)</math> for small values of <math>n</math></i> . . . . .	33
3.3	Making a digraph acyclic: related problems . . . . .	34
3.4	Inversion versus cycle (arc-) transversal and cycle packing . . . . .	36
3.5	Computing the inversion number of an oriented graph . . . . .	40
3.6	Inversion number of dijoins of oriented graphs . . . . .	43
3.6.1	<i>Dijoin of oriented graphs with inversion number 2</i> . . . . .	46
3.7	Inversion number of augmentations of oriented graphs . . . . .	55
3.8	Inversion number of intercyclic oriented graphs . . . . .	57
3.9	Complexity results on the inversion number . . . . .	61
3.9.1	<i>NP-hardness of 1-INVERSION and 2-INVERSION</i> . . . . .	61
3.9.2	<i>Solving <math>k</math>-TOURNAMENT-INVERSION for <math>k \in \{1, 2\}</math></i> . . . . .	63
3.9.3	<i>Computing related parameters when the inversion number is bounded</i> . . . . .	68
4	B-GREEDY COLOURINGS, Z-COLOURINGS AND ASSOCIATED PARAMETERS . . . . .	70
4.1	Graph colourings and colouring heuristics . . . . .	70
4.1.1	<i>Greedy colourings and <math>b</math>-colourings</i> . . . . .	71
4.1.2	<i><math>b</math>-greedy-colourings and <math>z</math>-colourings</i> . . . . .	75
4.2	NP-hardness . . . . .	84
4.3	Atoms and polynomial-time algorithms . . . . .	88
4.4	$b$ -greedy and $z$ -colourings in regular graphs . . . . .	90
4.5	$b$ -greedy and $z$ -colourings in Trees . . . . .	105

<b>5</b>	<b>CONCLUDING REMARKS AND OPEN PROBLEMS . . . . .</b>	<b>112</b>
	<b>REFERENCES . . . . .</b>	<b>115</b>
	<b>APPENDICES . . . . .</b>	<b>119</b>
	<b>APPENDIX A – From branchings to flows: a study of an Edmonds’ like property to arc-disjoint branching flows . . . . .</b>	<b>119</b>
	<b>APPENDIX B – Decomposição de Fluxos em Digrafos Arco-Coloridos</b>	<b>121</b>
	<b>APPENDIX C – New Menger-like dualities in digraphs and applica- tions to half-integral linkages . . . . .</b>	<b>123</b>



## 1 INTRODUCTION

In this thesis, we study some topics within the context of Graph Theory: *inversions of oriented graphs* and *b-greedy-colourings and z-colourings*. While the first topic relies on the domain of oriented graphs, the second is restricted to simple graphs.

Given an oriented graph  $D$  and a subset of its vertices  $X \in V(D)$ , we call the **inversion**  $X$  in  $D$  the operation that reverses the direction of all the arcs in  $A(D[X])$  while preserving the others, that is,  $A(D) \setminus A(D[X])$ . After operating the inversion of  $X$  in  $D$ , we obtain an oriented graph we denote by  $\text{Inv}(D; X)$ . For an arc  $vw \in A(D)$ , it follows that  $wv \in A(\text{Inv}(D; X))$  if  $v \in X$  and  $w \in X$ , otherwise  $vw \in A(\text{Inv}(D; X))$ . We can also consider a sequence of inversions. Let  $(X_i)_{i \in [k]}$  be a family of subsets of  $V(D)$ . Then, we denote by  $\text{Inv}(D; (X_i)_{i \in [k]})$  the digraph obtained after inverting the  $X_i$  one after another, that is,  $\text{Inv}(D; (X_1)_{[1]}) = \text{Inv}(D; X_1)$  and  $\text{Inv}(D; (X_i)_{i \in [k]}) = \text{Inv}(\text{Inv}(D; (X_i)_{i \in [k-1]}); X_k)$ . We point out that the order in which we perform the inversions does not affect  $\text{Inv}(D; (X_i)_{i \in [k]})$  because the final orientation of an arc depends exclusively on the number of times it was inverted which is the same for every order.

It seems that the inversion operation was first defined in (BELKHECHINE, 2009) and then it also appeared in (BELKHECHINE *et al.*, 2010) and (BELKHECHINE *et al.*, ). The latter is an unpublished manuscript. For a tournament  $T$ , they defined the **inversion number**  $\text{inv}(T)$  as the minimum integer  $k$  such that there exists a family of subsets  $(X_i)_{i \in [k]}$  in which  $\text{Inv}(D; (X_i)_{i \in [k]})$  is acyclic. Such family of subsets is called a **decycling family** of  $T$ . The inversion number can be seen as a measure of distance from a tournament to the acyclic (or transitive) tournament. In this context, the inversion number was mainly used as a tool to characterize some classes of tournaments. It was also considered the maximum inversion number of a tournament on  $n$  vertices denoted by  $\text{inv}(n)$  (BELKHECHINE, 2009).

We expanded the study of inversions to oriented graphs and also considered algorithmic aspects of computing inversions. We formalized the problem of finding a decycling family and studied it alongside other problems of making a digraph acyclic such as CYCLE ARC-TRANSVERSAL or FEEDBACK ARC SET and CYCLE TRANSVERSAL or FEEDBACK VERTEX SET. A **cycle transversal** (resp. **cycle arc-transversal**) of a digraph  $D$  is a subset of vertices  $F \subseteq V(D)$  (resp. of arcs  $F \subseteq A(D)$ ) such that  $D - F$  is acyclic. In other words, it is a subset of vertices (resp. of arcs) whose removal produces an acyclic digraph. The **cycle transversal number** (resp. cycle arc-transversal number) of a digraph  $D$ , denoted by  $\tau(D)$  (resp.  $\tau'(D)$ ), is the size of a minimum cycle transversal (resp. cycle arc-transversal) of  $D$ . The

problems of computing  $\tau$  and  $\tau'$  were between the first problems shown to be NP-hard listed by Karp in (KARP, 1972) and have been largely studied since then. In this thesis, we investigate the relations between  $\text{inv}(D)$  and  $\tau(D)$ ,  $\tau'(D)$  and  $\nu(D)$ . This last parameter is the **cycle packing number** of  $D$  which is the maximum size of a set of vertex disjoint cycles of  $D$ . We show that  $\text{inv}(D) \leq \tau'(D)$  and  $\text{inv}(D) \leq \tau(D)$  and that there is a function  $g$  such that  $\text{inv}(D) \leq g(\nu(D))$ . Moreover, we show that the distance between the inversion number and these parameters can be arbitrarily large.

It also seemed natural to redefine  $\text{inv}(n)$  as the maximum inversion number of an oriented graph on  $n$  vertices. But then we showed that  $\text{inv}(n)$  will always be achieved by a tournament on  $n$  vertices and, therefore, the generalization is equivalent to the restriction to tournaments. By previous results,  $\text{inv}(n)$  was known for  $n \leq 6$ , and we did some computational experiments to obtain  $\text{inv}(n)$  for  $n \in \{7, 8\}$ .

We also studied the inversion number of some specific classes of oriented graphs. In (BELKHECHINE *et al.*, ), the authors conjectured that  $\text{inv}(Q_n) = \lfloor \frac{n-1}{2} \rfloor$ , where  $Q_n$  is an oriented graph obtained by reversing the arcs of the hamiltonian path of a transitive tournament on  $n$  vertices. This is known to be true for  $n \leq 6$ . We showed that it holds for  $n = 7$  and our tests also suggests that it holds for  $n = 8$ .

Another oriented graph we investigated was the  $TT_n[\vec{C}_3]$ . This oriented graph is obtained by the lexicographic product of the transitive tournament on  $n$  vertices  $TT_n$  by the directed 3-cycle  $\vec{C}_3$ . It can be seen as the blowing up of every vertex of  $TT_n$  into a  $\vec{C}_3$ . In (POUZET *et al.*, 2021) it is shown that  $\text{inv}(TT_n[\vec{C}_3]) = n$ . In a search of an elementary proof for this result, we have studied the inversion number of dijoins of oriented graphs. For two oriented graphs  $L$  and  $R$ , the **djoin** from  $L$  to  $R$ , denoted by  $L \rightarrow R$ , is the oriented graph formed by the disjoint union of  $L$  and  $R$  along with all the possible arcs from the vertices of  $L$  to the ones of  $R$ . It is easy to see that  $\text{inv}(L \rightarrow R) \leq \text{inv}(L) + \text{inv}(R)$  but we conjecture that the equality holds, that is,  $\text{inv}(L \rightarrow R) = \text{inv}(L) + \text{inv}(R)$ . We managed to prove this conjecture when  $\text{inv}(L) = 1$  and  $\text{inv}(R) \in \{1, 2\}$ , and also when  $\text{inv}(L) = \text{inv}(R) = 2$  and both  $L$  and  $R$  are strongly connected.

On the complexity front, we defined and studied two problems:  $k$ -INVERSION and  $k$ -TOURNAMENT-INVERSION. On the first one, we want to decide for a given oriented graph  $D$  whether  $\text{inv}(D) \leq k$ . The second is similar but restricted to tournaments. The 0-INVERSION is simply the problem of deciding whether an oriented graph is acyclic, which is known to be polynomial. We showed that, for  $k \in \{1, 2\}$ ,  $k$ -inversion is NP-complete. We believe it remains

NP-complete for  $k \geq 3$ , which is the case if the conjecture we posed about dijoins is true.

Concerning the  $k$ -TOURNAMENT-INVERSION, it is polynomial for every fixed  $k \geq 1$ . This follows from a result of (BELKHECHINE *et al.*, 2010) which depends on the concept of  $k$ -inversion-critical tournaments. A tournament  $T$  is  **$k$ -inversion-critical** if  $\text{inv}(T) = k$  and  $\text{inv}(T - v) < k$ , for every  $v \in V(T)$ . Belkhechine *et al.* (2010) showed that the set  $\mathcal{IC}_k$  of  $k$ -inversion-critical tournaments is finite, for every  $k$ . For a given tournament  $T$ , one can decide whether  $\text{inv}(T) \leq k$ , by checking whether  $T$  contains no element of  $\mathcal{IC}_{k+1} \cup \mathcal{IC}_{k+2}$  as an induced subdigraph. This can be done in  $O(|V(T)|^{\max\{m_{k+1}, m_{k+2}\}})$ -time, where  $m_k$  is the maximum order of an element of  $\mathcal{IC}_k$ . But  $\mathcal{IC}_k$  is only known for  $k \leq 2$ , so the polynomial degree of this algorithm is unknown. In particular,  $m_1 = 3$  and  $m_2 \geq 6$  so, for  $k = 1$ , this algorithm is  $\Omega(n^6)$ . We show that with specific algorithms we can solve 1-TOURNAMENT-INVERSION in  $O(n^3)$ -time and 2-TOURNAMENT-INVERSION in  $O(n^6)$ -time. Our contributions to this first topic were presented at ALGOS 2020 and published in Discrete Mathematics & Theoretical Computer Science, see References (BANG-JENSEN *et al.*, 2020) and (BANG-JENSEN *et al.*, 2022).

A  **$k$ -colouring** of a graph  $G = (V, E)$  is a mapping  $\phi : V \rightarrow \{1, \dots, k\}$ , such that for any edge  $uv \in E(G)$ ,  $\phi(u) \neq \phi(v)$ , that is, every vertex receives a colour and neighbours have different colours. A  **$k$ -colouring** may also be seen as a partition of the vertex set of  $G$  into  $k$  disjoint **stable sets** (i.e. sets of pairwise non-adjacent vertices)  $S_i = \{v \mid \phi(v) = i\}$  for  $1 \leq i \leq k$  called **colour classes**. The **chromatic number**  $\chi(G)$  is the least  $k$  such that  $G$  admits a  $k$ -colouring. Determining the chromatic number of a graph is another problem in Karp's NP-hard list in (KARP, 1972). Deciding whether a graph admits a 3-colouring is already NP-complete and it remains NP-complete even when restricted 4-regular planar graphs (DAILEY, 1980). Moreover, Zuckerman (2007) showed that, unless  $P = NP$ , it is not possible to approximate the chromatic number within a factor of  $n^{1-\varepsilon}$ , for all  $\varepsilon > 0$ . In this situation, heuristics are the best option that one can expect to deal with this problem with some reasonable performance.

One of the most basic and popular heuristics is the greedy algorithm. In the **greedy algorithm**, the vertices of the input graph  $G$  are arranged in a linear order  $(v_1, v_2, \dots, v_n)$ , and then, following this order, the vertices are coloured one by one by assigning to  $v_i$  the smallest positive integer not used on its lower-index neighbours. Basically, in each step, the current vertex is coloured with the smallest colour available. The number of colours used by the greedy algorithm depends on the order which the vertices are coloured. We call **greedy colouring** any colouring that we can obtain by the greedy algorithm. A vertex  $v$  is **greedy** with respect to

some colouring  $\phi$  if it has least one neighbour of every colour in  $\{1, 2, \dots, \phi(v) - 1\}$ . A greedy colouring can also be defined as a colouring on which every vertex is greedy. The **Grundy number** of  $G$ , denoted by  $\Gamma(G)$ , is the worst case of this heuristic for the graph  $G$ , in other words, is the maximum  $k$  such that  $G$  has a  $k$ -greedy colouring (CHRISTEN; SELKOW, 1979).

For the next heuristic, we need the concept of b-vertex. Let  $G$  be a graph and let  $\phi$  be a  $k$ -colouring of  $G$ . A vertex  $v \in V(G)$  is a **b-vertex** with respect to  $\phi$  if it has at least one neighbour of every colour in  $\{1, 2, \dots, k\} \setminus \phi(v)$ . In other words,  $v$  has a neighbour of every colour but its own. Recall that  $S_i$  is the set of vertices with colour  $i$ . If some  $S_i$  has no b-vertex it is possible to recolour every vertex in  $S_i$  with a colour which is not in its neighbourhood. Doing this, we find another colouring with no vertex of colour  $i$ , that is, a colouring with one colour less. So, the b-colouring heuristic repeatedly checks whether there is a colour with no b-vertex and eliminates such a colour and stops when every colour has a b-vertex. A  **$k$ -b-colouring** is a colouring on which, for every  $1 \leq i \leq k$ , there is a b-vertex in  $S_i$ . The **b-chromatic number**  $\chi_b(G)$  is the maximum  $k$  such that  $G$  admits a  $k$ -b-colouring (IRVING; MANLOVE, 1999).

Zaker (2020) managed to combine greedy colourings and b-colourings into a single heuristic he called z-colouring. He first showed that any greedy  $k$ -colouring can be improved into a  $k'$ -colouring, with  $k' \leq k$ , which is simultaneously a greedy colouring and a b-colouring. We call such colouring as  **$k'$ -b-greedy colouring**. Then, he also showed that every  $q$ -b-greedy colouring can be improved into a  $q'$ -b-greedy colouring such that  $q' \leq q$  and there is a set of b-vertices  $\{u_1, u_2, \dots, u_{q'}\}$  with following property: for every  $i$ , the colour of  $u_i$  is  $i$  and for every  $j \neq q'$ ,  $u_{q'}$  is neighbour of  $u_j$ . A b-greedy colouring with this property is a **z-colouring**. The **b-Grundy number**  $\Gamma_b(G)$  is the largest  $k$  such that  $G$  admits a  $k$ -b-greedy colouring. Similarly, the **z-number**  $z(G)$  is the largest  $k$  such that  $G$  admits a  $k$ -z-colouring.

Zaker showed that one can build a graph  $H$  for which  $\min\{\Gamma(H), \chi_b(H)\}$  can be arbitrarily large while  $z(H) \leq 3$ . He also showed how to construct for every positive integer  $t$  a finite family of coloured graphs  $\mathcal{D}_t$  holding the following property: if  $z(G) \geq t$  for a graph  $G$ , then  $G$  have an element of  $\mathcal{D}_t$  as a coloured subgraph. The elements of  $\mathcal{D}_t$  are called z-atoms (in (ZAKER, 2006), he had defined the  $t$ -atoms to show an equivalent result regarding the Grundy number of a graph). Moreover, in (ZAKER, 2020) it is shown that determining the z-number of a tree is a polynomial time solvable problem and that the smallest tree  $\mathcal{T}$  with  $z(\mathcal{T}) = k$  has  $(k - 3)2^{k-1} + k + 2$  vertices.

Since Zaker used b-greedy colourings only as an intermediary step to obtain z-

colourings he never even mentioned the b-Grundy number in (ZAKER, 2020). We took a step back and studied whether the results of (ZAKER, 2020) regarding  $z(G)$  could also apply to  $\Gamma_b(G)$ . By definition, we have that  $z(G) \leq \Gamma_b(G) \leq \min\{\Gamma(G), \chi_b(G)\}$ . We show how to build a graph  $H'$  with  $z(H') \leq \Gamma_b(H') \leq 2$  and with  $\min\{\Gamma(H'), \chi_b(H')\}$  as large as we want.

We also studied basic properties of greedy colourings and b-colourings to see whether they were inherited by b-greedy colourings and z-colourings. It is known, that the Grundy number of a graph is equal to the maximum of the Grundy numbers of its connected components, and the b-chromatic number is at least the maximum of the b-chromatic numbers of its connected components. We show that, in this matter, the z-number keeps the behaviour of the Grundy number while the b-Grundy number behaves like the b-chromatic number.

Another properties we investigated were the z-spectrum and  $\Gamma_b$ -spectrum of a graph. The **z-spectrum** (resp.  **$\Gamma_b$ -spectrum**,  **$\Gamma$ -spectrum**,  **$\chi_b$ -spectrum**) of a graph  $G$ , is the set of values  $k$  such that  $G$  admits a  $k$ -z-colouring (resp.  $k$ -b-greedy colouring,  $k$ -greedy colouring,  $k$ -b-colouring), denoted by  $z\text{-spec}(G)$  (resp.  $\Gamma_b\text{-spec}(G)$ ,  $\Gamma\text{-spec}(G)$ ,  $\chi_b\text{-spec}(G)$ ). For a parameter  $\gamma$  in  $\{z, \Gamma_b, \Gamma, \chi_b\}$ , we say that  $G$  is  **$\gamma$ -continuous** if  $\gamma\text{-spec}(G) = \{\chi(G), \dots, \gamma(G)\}$ . It is well-known that every graph is  $\Gamma$ -continuous (see e.g. (HAVET *et al.*, 2022)) while many graphs are not  $\chi_b$ -continuous (see e.g. (JAKOVAC; PETERIN, 2018)). We show that all trees are  $\Gamma_b$ -continuous and z-continuous, but in general, some graphs are neither one nor the other.

Regarding **cubic** graphs, that is, graphs in which all vertices have degree 3, we considered two results. The first is from (JAKOVAC; KLAUVŽAR, 2010) and states that every cubic graph has b-chromatic number 4 except for: the complete bipartite  $K_{3,3}$ , the prism  $K_3 \square K_2$ , the Petersen graph  $P_{10}$  and another graph  $G_{10}$ . The second is from (GASTINEAU *et al.*, 2014) and states that if  $G$  is a cubic graph and  $G$  has no induced  $C_4$ , then  $\Gamma(G) = 4$ . From the four exceptions from the first result, the only graph with no induced  $C_4$  is the Petersen graph. Then, we proved the following: if  $G$  is a cubic graph with no induced  $C_4$  and  $G$  is not the Petersen graph, then  $z(G) = \Gamma_b(G) = 4$ .

We also have some complexity results concerning the b-Grundy number and the z-number. We adapted a result from (HAVET; SAMPAIO, 2013) to show that is NP-complete to decide whether a given bipartite graph  $G$  such that  $\Gamma(G) = \Delta(G) + 1$  or  $\chi_b(G) = \Delta(G) + 1$  satisfies  $z(G) = \Delta(G) + 1$  and we have the same hardness result if we want to decide  $\Gamma_b(G) = \Delta(G) + 1$  instead. Extending this proof, we also show the NP-hardness of deciding whether  $z(G) = \Gamma_b(G)$  for a given graph  $G$ .

In (SAMPAIO, 2012), it is proved that for any parameter  $\gamma_1$  in  $\{\Gamma, \chi_b\}$ , it is NP-hard to decide whether  $\gamma_1(G) = \omega(G)$  and coNP-complete to decide whether  $\gamma_1(G) = \chi(G)$ . For the parameters  $\gamma_1$  in  $\{z, \Gamma_b\}$  and  $\gamma_2$  in  $\{\omega, \chi, \Gamma, \chi_b\}$ , we show that to decide whether  $\gamma_1(G) = \gamma_2(G)$  is NP-complete when  $\gamma_2 \in \Gamma, \chi_b$  and coNP-hard when  $\gamma_2 \in \{\omega, \chi\}$  (Theorem 4.2.1 and Corollary 4.2.2 and Corollary 4.2.3).

In contrast, we show in Corollary 4.4.12 that one can decide in polynomial time whether a  $k$ -regular graph has  $z$ -number (resp.  $b$ -Grundy number  $k + 1$ ). Computing the Grundy number (BEYER *et al.*, 1982), the  $b$ -chromatic number (IRVING; MANLOVE, 1999) and the  $z$ -number (ZAKER, 2020) of a tree can be done in polynomial time. We also show that deciding whether the  $b$ -Grundy number of a tree is at least  $k$  can be done in polynomial time for every fixed  $k$ .

Our contributions to this second topic were submitted to the Discrete Applied Mathematics and are also available at SSRN on the following link: <<https://ssrn.com/abstract=4341924>>. Concurrently, some of these contributions were proved by Khaleghi and Zaker and recently published in (KHALEGHI; ZAKER, 2023).

This document is organized as follows. In Chapter 2, we present some basic concepts of graph theory. In Chapter 3, we discuss our results on inversions of oriented graphs and, in Chapter 4, we present our contributions to the topic of  $b$ -Greedy-colourings and  $z$ -colourings. In Chapter 5, we present our conclusions and some directions for further research.

Besides the results presented here, other topics were studied alongside this thesis in collaboration with other PhD students and researchers. The first one concerns arc-disjoint branching flows. A *branching flow* is a single-sourced flow in which every vertex receives at least one flow unit. We adapted Edmonds' characterization of digraphs containing  $k$  arc-disjoint branchings to the context of arc-disjoint flows and investigated whether this adaptation characterizes the existence of  $k$  arc-disjoint branching flows.

We also studied flows in arc-coloured networks. In particular, we considered the problem of decomposing a given arc-coloured  $(s, t)$ -flow in order to minimize the number paths with many colours.

In a third work, we studied the half-integral  $k$ -linkage problem. This problem is believed to be polynomial for every fixed  $k$ , but whether this is true or not is open for  $k \geq 3$ . As a result, we introduced new Menger-like dualities in digraphs and used them to improve and simplify some results of restricted versions of the half-integral  $k$ -linkage problem. In appendices

A, B and C, we present the abstracts of the articles accepted/submitted as result of those works.

## 2 BASIC CONCEPTS

In this chapter, we present some definitions and notations related to the content of this thesis. Most of these concepts are standard. See (BONDY; MURTY, 2008) and (BANG-JENSEN; GUTIN, 2009) for example.

### 2.1 Graphs

A **graph**  $G$  is defined by an ordered pair  $(V(G), E(G))$  and an **incidence function**  $\psi_G$ . Furthermore,  $V(G)$  is a finite set of **vertices**,  $E(G)$  is a finite set, disjoint of  $V(G)$ , of **edges** and  $\psi_G$  associates each edge of  $G$  with an unordered pair of vertices of  $G$  (not necessary distinct). For an edge  $e \in E(G)$ , if  $u$  and  $v$  are vertices of  $G$  such that  $\psi_G(e) = \{u, v\}$  we say that  $u$  and  $v$  are the **extremities** or **end-vertices** of  $e$ . For simplicity, we generally omit the incidence function and we write  $uv$  to denote an edge with end-vertices  $u$  and  $v$ . We say that the vertices  $u$  and  $v$  are **adjacent** or **neighbours** if there is an edge  $uv \in E(G)$ . The **order** and the **size** of a graph  $G$  are respectively given by  $|V(G)|$  and  $|E(G)|$ . When the context is clear we also reserve the letters  $n$  and  $m$  to respectively denote the number of vertices and edges of a graph.

An edge is called a **loop** if its extremities are identical, and two edges are **parallel** if they have the same **end-vertices**. A **simple graph** is a graph without loops and parallel edges. In this thesis, we only deal with simple graphs, so from this point on, we will use the term graph to refer to a simple graph. We point out that some of the following definitions may vary when dealing with loops and parallel edges.

We graphically represent graphs by drawing a circle for each vertex and drawing a line connecting the two circles corresponding to the end-vertices of each edge. When relevant, we put labels inside or around the circles and lines to indicate their respective vertices and edges. For example, in Figure 1, we depicted the graph  $G_1 = (\{a, b, c, d\}, \{ab, e = ad, dc, db, cb\})$ .

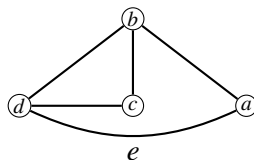

Figure 1 – An example of a graph  $G_1$  of order 4.

Let  $v$  be a vertex of a graph  $G$ . The **neighbourhood** of  $v$  in  $G$ , denoted by  $N_G(v)$ ,



is the set of vertices adjacent to  $v$ , that is,  $N_G(v) = \{w \in V(G) \mid vw \in E(G)\}$ . The **degree** of  $v$  in  $G$ , denoted by  $d_G(v)$ , is the number of neighbours of  $v$  in  $G$ , that is,  $d_G(v) = |N_G(v)|$ . These two notions can be extended to a set of vertices  $S \subseteq V(G)$ :  $N_G(S) = (\bigcup_{v \in S} N_G(v)) \setminus S$  and  $d_G(S) = |N_G(S)|$ . We denote by  $\Delta(G)$  (resp.  $\delta(G)$ ) the **maximum degree** (resp. **minimum degree**) of  $G$  which is given by the maximum (resp. minimum) integer  $k$  such that  $G$  has a vertex of degree  $k$ . Considering again the example of Figure 1, we have that  $N_{G_1}(c) = \{b, d\}$  and that  $\Delta(G_1) = d_{G_1}(b) = 3$ . When the graph is clear in the context, we may omit the subscript from notation.

A graph  $H$  is a **subgraph** of  $G$  if  $V(H) \subseteq V(G)$  and  $E(H) \subseteq E(G)$ . If  $V(H) = V(G)$ , we say that  $H$  is a **spanning subgraph** of  $G$ . When  $E(H) = \{uv \in E(G) \mid u, v \in V(H)\}$  we say that  $H$  is an **induced subgraph** of  $G$ , that is, each edge of  $E(G)$  with both end-vertices in  $V(H)$  is also in  $E(H)$ . We also say that  $H$  is **induced** by  $X = V(H)$  and we write  $H = G[X]$ . See Figure 2a for an example. In every case, we say that  $G$  is a **supergraph** of  $H$ . For a set of vertices  $S$  of  $G$ , we use  $G - S$  to denote the subgraph  $H = G[V(G) \setminus S]$ . Similarly, for a set of edges  $T$ ,  $G - T$  is the subgraph  $H' = (V(G), E(G) \setminus T)$ . For simplicity, when  $S = \{v\}$  and  $T = \{vw\}$ , we write  $G - v$  and  $G - vw$ . See Figures 2b and 2c.

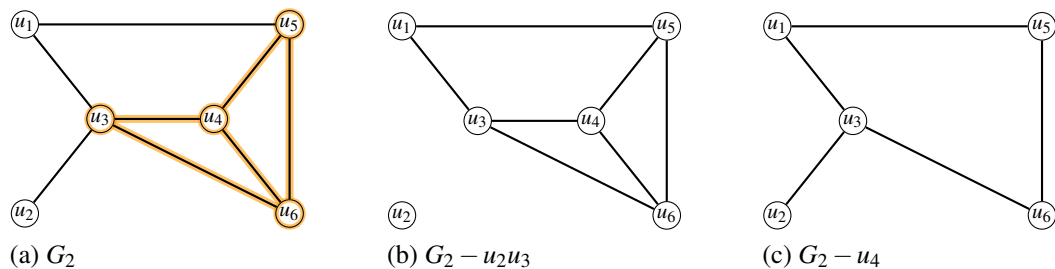

Figure 2 – Examples of subgraphs of the graph  $G_2$ . (a) The graph  $G_2$  and  $G_2[\{u_3, u_4, u_5, u_6\}]$  (highlighted). (b)  $G_2 - u_2u_3$ . (c)  $G_2 - u_4$ .

Two graphs  $G$  and  $H$  are **isomorphic** if there is a bijective function  $\phi : V(G) \rightarrow V(H)$  such that  $vw \in E(G)$  if and only if  $\phi(v)\phi(w) \in E(H)$ . When  $H$  is isomorphic to a subgraph of  $G$ , we say that  $G$  has  $H$  as a subgraph. For example,  $G_2$  has  $G_1$  as a subgraph. Observe that  $G_2[\{u_3, u_4, u_5, u_6\}]$  in Figure 2a is isomorphic to  $G_1$  (Figure 1).

The graphs  $G$  and  $H$  are **disjoint** if  $V(G) \cap V(H) = \emptyset$ . Let  $G$  and  $H$  be two disjoint graphs. If they are isomorphic, we say that  $H$  is a **copy** of  $G$  and vice versa. Their **disjoint union** is the graph  $G + H = (V(G) \cup V(H), E(G) \cup E(H))$ . We can extend this operation to an arbitrary

number of graphs and, for any positive integer  $k$ , we denote by  $kG$  the disjoint union of  $k$  copies of  $G$ .

The **complement of a graph**  $G$  is the graph  $\overline{G} = (V(G), \{vw \mid vw \notin E(G)\})$ . A **clique** in graph  $G$  is a set of vertices which are pairwise adjacent in  $G$ . The **clique number** of  $G$  is the largest  $k$  such that  $G$  has a clique of cardinality  $k$  and is denoted by  $\omega(G)$ . A **stable set** (or an **independent set**) in a graph  $G$  is a set of pairwise non-adjacent vertices of  $V(G)$ , and the size of a maximum stable set of  $G$  is denoted by  $\alpha(G)$ . The sets  $\{u_3, u_5, u_3\}$  and  $\{u_1, u_2, u_4\}$  are respectively a clique and an independent set of  $G_2$  (Figure 2a).

### 2.1.1 Special classes of graphs

A **complete graph** is a graph in which every pair of vertices are adjacent. We denote the complete graph of order  $n$  by  $K_n$ . See Figure 6a for an example of  $K_5$ .

A graph is **bipartite** when its vertex set can be partitioned into stable sets  $X$  and  $Y$ . We write  $G = [X, Y]$  and we say that  $(X, Y)$  is a **bipartition** of  $G$ . The **complete bipartite graph**  $K_{i,j}$  is the bipartite graph  $G[X, Y]$  in which  $|X| = i, |Y| = j$  and  $xy \in E(G)$  for every  $x \in X, y \in Y$ . A **star** of order  $k$  is the complete bipartite graph  $K_{1,k-1}$ . See Figure 3.



Figure 3 – Two complete bipartite graphs: (a)  $K_{3,3}$  and (b)  $K_{1,4}$ , the star of order 5.

A **path**  $P$  is a graph with vertex set  $V(P) = \{v_1, v_2, \dots, v_n\}$  and edge set  $E(P) = \{v_i v_{i+1} \mid i \in [n-1]\}$ <sup>1</sup>. A path in a graph  $G$  is a subgraph of  $G$  which is isomorphic to a path. We say that  $P$  is  $(v_1, v_n)$ -path or a path between  $v_1$  and  $v_n$ , and we call these vertices the **extremities** of  $P$ . Similarly, a **cycle**  $C$  is a graph with vertex set  $V(C) = \{v_1, v_2, \dots, v_n\}$ , for  $n \geq 3$ , and edge set  $E(C) = \{\{v_1 v_n\} \cup \{v_i v_{i+1} \mid i \in [n-1]\}\}$ , and a subgraph of  $G$  isomorphic to a cycle is a cycle in  $G$ . The **length** of a path or a cycle is the size of its edge set. We denote the path and

<sup>1</sup> For a positive integer  $k$ , the notation  $[k]$  is used to represent the set  $\{1, 2, \dots, k\}$ .

the cycle of order  $k$  by  $P_k$  and  $k$ -cycle, respectively. In particular, the 3-cycle is also called a **triangle**. A graph is acyclic if it has no cycle as a subgraph. The **girth** of a graph  $G$  is the length of its shortest cycle (or  $+\infty$  if  $G$  has no cycle). While a single vertex may be considered a path, it is not considered a cycle (when loops are excluded), and since simple graphs do not admit cycles of length 2, the girth of any simple graph is at least 3.

A graph is **connected** if it has a  $(u, v)$ -path for every pair of vertices  $u, v \in V(G)$ . Otherwise, it is called **disconnected**. For an example of a disconnected graph, see Figure 2b. A maximal subgraph of  $G$  with the property of being connected is called a **connected component** or (simply **component**) of  $G$ . The **distance** between two vertices  $u$  and  $v$  is the smallest length of a path between  $u$  and  $v$ , and it is denoted by  $\text{dist}_G(u, v)$ . The **diameter** of a graph  $G$  is the greatest distance between two of its vertices (or  $+\infty$  if it is disconnected) and denoted by  $\text{diam}(G)$ .

A **tree** is a connected acyclic graph. Since any connected component of an acyclic graph is a tree, an acyclic graph is called **forest**. Every non-empty tree has at least one **leaf**, which is a vertex of degree one. If  $T$  is a tree and  $v \in V(T)$  is a leaf, then  $T - v$  is also a tree. For an example of tree see also Figure 3b.

A graph is  **$d$ -regular** if all of its vertices have degree exactly  $d$ . The  $K_n$  is  $(n - 1)$ -regular and the complete bipartite graph  $K_{n,n}$  is  $n$ -regular. In particular, 3-regular graphs are also called **cubic graphs**. The  $K_5$  (Figure 6a) is a 4-regular and  $K_{3,3}$  (Figure 3a) is a cubic graph.

## 2.2 Directed graphs

A **directed graph** or simply a **digraph**  $D$  is defined by an ordered pair  $(V(D), A(D))$  and an **incidence function**  $\psi_D$ . Moreover,  $V(D)$  is a finite set of **vertices**,  $A(D)$  is a finite set, distinct of  $V(D)$ , of **arcs**, and  $\psi_D$  associates each arc of  $D$  with an *ordered* pair of vertices of  $D$  (not necessarily distinct). Let  $a$  be an arc of  $D$ . If  $u$  and  $v$  are vertices of  $D$  such that  $\psi(a) = (u, v)$ , we say  $u$  and  $v$  are the **extremities** or **end-vertices** of  $a$ . Moreover, we say that  $u$  **dominates**  $v$  and that  $u$  is the **tail** while  $v$  is the **head** of  $a$ . For simplicity, we generally omit the incidence function  $\psi_D$ , and we write  $uv$  to denote an arc with end-vertices  $u$  and  $v$ .

An arc is a **loop** if its extremities are identical, and two arcs are **parallel** if they have the same head and the same tail. In this thesis, we only deal with digraphs without loops.

The **in-neighbours** of a vertex  $v$  are the vertices which dominate  $v$ , and those dominated by  $v$  are its **out-neighbours**. We respectively denote these sets by  $N_D^-(v)$  and  $N_D^+(v)$ . We denote by  $d_D^-(v)$  and  $d_D^+(v)$  the **in-degree** and **out-degree** of a vertex  $v$  which are respectively

given by the number of arcs with head  $v$  and the number of arcs with tail  $v$ . A vertex is a **source** if it has in-degree zero, and it is a **sink** if it has out-degree zero. It is useful to extend these concepts related to neighbourhood to a set of vertices  $S \subseteq V(D)$ , for example,  $N_D^-(S) = (\bigcup_{v \in S} N_D^-(v)) \setminus S$ . We can define  $N_D^+(S)$ ,  $d_D^-(S)$  and  $d_D^+(S)$  analogously.

Consider the digraph  $D_4$  depicted in Figure 4. Observe that  $d_{D_4}^-(c) = 1$ ,  $d_{D_4}^+(c) = 2$ ,  $d$  is a sink and that  $D_4$  has no source.

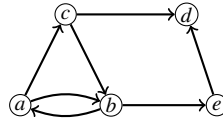

Figure 4 – The digraph  $D_4$ .

The concepts of **order**, **size**, **subdigraphs**, **isomorphism**, **disjointness**, and **disjoint union** of digraphs can be naturally extended from those presented to (undirected) graphs.

### 2.2.1 Special classes of digraphs

A **directed path**  $P$  is a digraph with vertex  $V(P) = \{v_1, v_2, \dots, v_n\}$  and edge set  $E(P) = \{v_i v_{i+1} \mid i \in [n-1]\}$  or a digraph isomorphic to  $P$ . Analogously, a **directed cycle**  $C$  is a digraph with vertex set  $V(C) = \{v_1, v_2, \dots, v_n\}$  and edge set  $E(C) = \{v_n v_1\} \cup \{v_i v_{i+1} \mid i \in [n-1]\}$  or a digraph isomorphic to  $C$ . We also say that  $P$  is a directed  $(v_1, v_n)$ -path or a path from  $v_1$  to  $v_n$ . The **length** of a directed path or a directed cycle is the size of its edge set. We denote the path and of order  $k$  by  $\vec{P}_k$ . For the directed cycle of order  $k$  we use directed  $k$ -cycle and also  $\vec{C}_k$ . Observe that in digraphs a directed 2-cycle is possible (see Figure 4). Such a cycle is called **digon**.



Figure 5 – A directed path and a directed cycle.

A digraph is **acyclic** if it has no directed cycles. Acyclic digraphs are also called

**DAGs** for short to *directed acyclic graphs*.

An **oriented graph**  $D$  is a digraph without digons. The **underlying graph** of an oriented graph  $D$ , denoted by  $UG(D)$ , is the graph obtained by ignoring the orientations of the arcs of  $D$ , that is,  $UG(D) = (V(D), \{v, w \mid (v, w) \in A(D)\})$ . If  $G = UG(D)$ , we say that  $D$  is **orientation** of  $G$ . In Figure 6b, we have an orientation of  $K_5$  (Figure 6a).

A **tournament** is an orientation of a complete graph. Since an induced subdigraph of a tournament is also a tournament, we call it a **subtournament**. A **transitive tournament** is an acyclic tournament. We often use  $TT_n$  to denote the transitive tournament of order  $n$ . See Figure 6b.



Figure 6 – A  $K_5$  (a) and an orientation of  $K_5$  (b).

A digraph  $D$  is **strongly connected** or **strong** if for every pair of vertices  $u, v \in V(D)$ , there is a directed  $(u, v)$ -path *and* a directed  $(v, u)$ -path in  $D$ . A maximal strong subdigraph of  $D$  is called a **strong component** of  $D$ .

The **lexicographic product** of a digraph  $D$  by another digraph  $H$ , denoted by  $D[H]$ , is the digraph with vertex set  $V(D[H]) = V(D) \times V(H)$  and arc set  $A(D[H]) = \{(u, w)(v, x) \mid \text{either } uv \in A(D) \text{ or } u = v \text{ and } wx \in A(H)\}$ . This graph may be seen as each vertex of  $D$  was blown up into a copy of  $H$ .

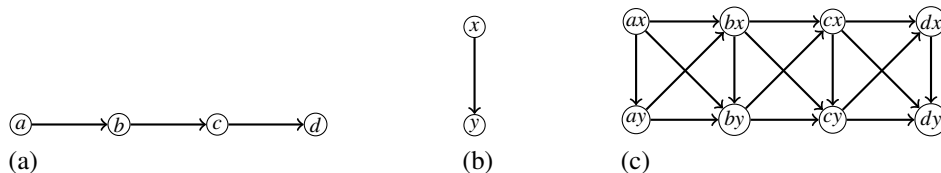

Figure 7 – A directed  $\vec{P}_4$  (a), a directed  $\vec{P}_2$  (b), and the lexicographic product  $\vec{P}_4[\vec{P}_2]$  (c).

### 3 INVERSIONS OF ORIENTED GRAPHS

At the introduction we have defined the **inversion** operation restricted to oriented graphs, but here we first look to it in a more general way. Let  $D$  be a digraph and  $X$  a subset of its vertices. The **inversion** of  $X$  in  $D$  consists in reversing the direction of all arcs of  $D[X]$  producing a new digraph we denote by  $\text{Inv}(D; X)$ . More formally, let  $A^r$  be the arcs of  $D[X]$  reversed, i.e.,  $A^r = \{vw : vw \in A(D[X])\}$ , then,  $\text{Inv}(D; X)$  is the digraph with vertex set  $V(D)$  and arc set  $A^r \cup (A(D) \setminus A(D[X]))$ . We may also say that we **invert**  $X$  in  $D$ . See Figure 8 for an example.

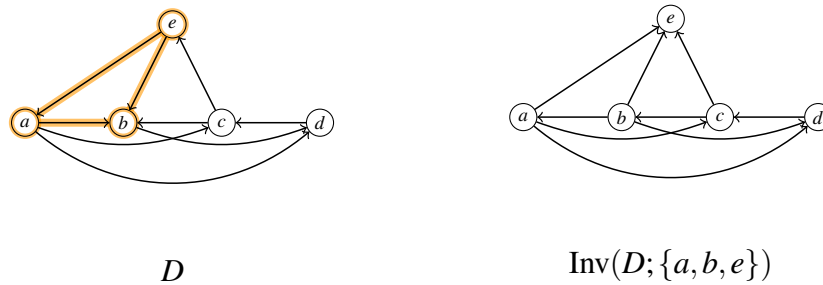

Figure 8 – A digraph  $D$  on the left and  $\text{Inv}(D; \{a, b, e\})$  on the right. The highlighted subdigraph on the left stands for  $D[\{a, b, e\}]$ .

If  $(X_i)_{i \in I}$  is a family of subsets of  $V(D)$ , then we denote by  $\text{Inv}(D; (X_i)_{i \in I})$  the digraph obtained after inverting the  $X_i$  one after another. We can formally define  $\text{Inv}(D; (X_i)_{i \in I})$  iteratively by the following algorithm:

---

**Algoritmo 1:** Algorithm for computing  $\text{Inv}(D; (X_i)_{i \in I})$

---

**Input:** A digraph  $D$  and a family of subsets of  $V(D)$ :  $(X_i)_{i \in I}$

$D_0 \leftarrow D$

**for**  $i \in I$  **do**

$D_i \leftarrow \text{Inv}(D_{i-1}; X_i)$

**end for**

**return**  $D_I$

---

The digraph  $D_I$ , returned by Algorithm 1, corresponds to  $\text{Inv}(D; (X_i)_{i \in I})$ , but defining it this way may look biased because the order on which we perform the inversions does not change the resulting graph. In fact,  $\text{Inv}(D; (X_i)_{i \in I})$  is obtained from  $D$  by reversing the arcs such that an odd number of the  $X_i$  contain its two end-vertices. With that said, we can give an equivalent definition for  $\text{Inv}(D; (X_i)_{i \in I})$ . Given a digraph  $D$  and a family of subsets  $(X_i)_{i \in I}$ ,

we define for every arc  $uv \in A(D)$  the set  $I^{uv} = \{i \in I : X_i \cap \{u, v\} = \{u, v\}\}$  which stands for the set of indexes of the subsets which contain both end-vertices of  $uv$ . Observe that  $|I^{uv}|$  is equal to the number of times that the arc  $uv$  will be inverted if we apply the Algorithm 1 to compute  $\text{Inv}(D; (X_i)_{i \in I})$ . Then,  $\text{Inv}(D; (X_i)_{i \in I})$  is the digraph with vertex set  $V(D)$  and arc set  $A' = \{uv : uv \in A(D) \text{ and } |I^{uv}| \text{ is even}\} \cup \{vu : uv \in A(D) \text{ and } |I^{uv}| \text{ is odd}\}$ .

### 3.1 Decycling family and inversion number of oriented graphs

The inversion operation was introduced by Belkhechine (2009), where the author investigated the minimum number of inversions necessary to turn a tournament into an acyclic tournament. We are interested in the more general version of this application not restricted tournaments. Since an inversion preserves the directed cycles of length 1 and 2, a digraph can be made acyclic (through inversions) only if it has no directed cycle of length 2, that is, if it is an orientation of a simple graph or an **oriented graph**. Under this restriction, we have that for any two orientations of the same graph, we can always convert one into the other using inversions:

**Proposition 3.1.1.** *Let  $D_1$  and  $D_2$  be two orientations of a graph  $G$ . There is a family of subsets  $(X_i)_{i \in I}$  such that  $D_1 = \text{Inv}(D_2; (X_i)_{i \in I})$ .*

*Proof.* Take  $(X_i)_{i \in I}$  to be the family of subsets  $\{u, v\}$  such that  $uv \in A(D_1)$  and  $vu \in A(D_2)$ .  $\square$

Since we are interested in convert a given orientation into an acyclic one, let us argue that this is always possible:

**Proposition 3.1.2.** *Let  $D$  be an orientation of a graph  $G$ . There is a family of subsets  $(X_i)_{i \in I}$  of  $V(D)$ , such that  $\text{Inv}(D; (X_i)_{i \in I})$  is acyclic.*

*Proof.* We only need to show that  $G$  always admits an acyclic orientation  $D_2$ , then, the result will follow directly from Proposition 3.1.1. Let  $T$  be a transitive tournament on the vertices of  $G$ . Then we take  $D_2$  as the subdigraph of  $T$  which is an orientation of  $G$ , i.e,  $D_2 = T \setminus \{uv, vu : uv \in E(\bar{G})\}$ .  $\square$

From this point, we deal with orientations as a class of digraphs in the sense that the underling graph is not particularly relevant. So, we prefer the term oriented graph in this context.

A **decycling family** of an oriented graph  $D$  is a family of subsets  $(X_i)_{i \in I}$  of subsets of  $V(D)$  such that  $\text{Inv}(D; (X_i)_{i \in I})$  is acyclic. The **inversion number** of an oriented graph  $D$ ,

denoted by  $\text{inv}(D)$ , is the minimum number of inversions needed to transform  $D$  into an acyclic digraph, that is, the minimum cardinality of a decycling family. By convention, the empty digraph (no arcs) is acyclic and so has inversion number 0. Let  $V_5$  be the tournament depicted in

(a) The tournament  $V_5$ .(b)  $\text{Inv}(V_5; (X_1, X_2))$ 

Figure 9 – Example of inversions of a tournament with inversion number two.

Figure 9a. Observe that  $(X_1 = \{v_1, v_2, v_3, v_4\}, X_2 = \{v_5, v_3\})$  is a decycling family of  $V_5$  because  $\text{Inv}(V_5; (X_1, X_2))$  (Figure 9b) is acyclic. This tournament has inversion number 2 so we cannot make it acyclic with one inversion (See Section 3.2).

### 3.2 Properties and bounds of the inversion number

In this section, we establish some properties of the inversion number that should be useful over the next sections.

Next, we show that the inversion number is a monotone parameter.

**Proposition 3.2.1.** *If  $D'$  is a subdigraph of an oriented graph  $D$ , then  $\text{inv}(D') \leq \text{inv}(D)$ .*

*Proof.* Let  $D'$  be a subdigraph of  $D$ . Since any subdigraph of an acyclic digraph is acyclic, if  $(X_i)_{i \in I}$  is a decycling family of  $D$ , then  $(X_i \cap V(D'))_{i \in I}$  is a decycling family of  $D'$ .  $\square$

The above result implies that, in general, removing vertices or arcs from an oriented graph tends to decrease the inversion number. Although, there are vertices that we can always remove from an oriented graph without changing its inversion number.

**Lemma 3.2.2.** *Let  $D$  be an oriented graph. If  $D$  has a source (a sink)  $x$ , then  $\text{inv}(D) = \text{inv}(D - x)$ .*

*Proof.* Every decycling family of  $D - x$  is also a decycling family of  $D$  since adding a source (sink) to an acyclic digraph results in an acyclic digraph.  $\square$

This means that we can freely ignore sources and sinks when looking for a decycling family. By adding 2 inversions, we can ignore any vertex by turning it into a source (or sink).



**Lemma 3.2.3.** *Let  $D$  be an oriented graph and let  $x \in V(D)$ . Then,  $\text{inv}(D) \leq \text{inv}(D - x) + 2$ .*

*Proof.* Let  $N^+[x]$  be the closed out-neighbourhood of  $x$ , that is  $\{x\} \cup N^+(x)$ . Observe that  $D' = \text{Inv}(D; (N^+[x], N^+(x)))$  is the oriented graph obtained from  $D$  by reversing the arcs between  $x$  and its out-neighbours. Hence  $x$  is a sink in  $D'$  and  $D' - x = D - x$ . Thus, by Lemma 3.2.2,  $\text{inv}(D) \leq \text{inv}(D') + 2 \leq \text{inv}(D - x) + 2$ .  $\square$

Lemmas 3.2.2 and 3.2.3 lead to an algorithm for obtaining a decycling family of an oriented graph  $D$ .

---

**Algorithm 2:** Algorithm for computing a decycling family

---

**Input:** An oriented graph  $D$   
 $X \leftarrow$  an empty family of subsets  
 $D' \leftarrow D$   
**while**  $D'$  is not acyclic **do**  
     $S \leftarrow$  source and sink nodes of  $D'$   
     $D' \leftarrow D' \setminus S$   
     $v \leftarrow$  a vertex of  $D'$   
    add  $N^+[v]$  and  $N^+(v)$  to  $X$   
**end while**  
**return**  $X$

---

In the worst scenario, where only one vertex is removed at a time, the Algorithm 2 will output a decycling family of size  $2(n - 2)$ . This is very far from optimal because, as we can see in Corollary 3.2.6, an oriented graph with  $n$  vertices has inversion number at most  $n - 4$ .

Let  $D$  be an oriented graph. An **extension** of  $D$  is any tournament  $T$  such that  $V(D) = V(T)$  and  $A(D) \subseteq A(T)$ .

**Lemma 3.2.4.** *Let  $D$  be an oriented graph. There is an extension  $T$  of  $D$  such that  $\text{inv}(T) = \text{inv}(D)$ .*

*Proof.* Set  $p = \text{inv}(D)$  and let  $(X_i)_{i \in [p]}$  be a decycling family of  $D$ . Then  $D^* = \text{Inv}(D; (X_i)_{i \in [p]})$  is acyclic and so admits an acyclic ordering  $(v_1, \dots, v_n)$ . Recall that  $[p]^{uv}$  stands for the subset of indexes  $i$  such that both  $u$  and  $v$  belong to  $X_i$ .

Let  $T$  be the extension of  $D$  constructed as follows: For every  $1 \leq k < \ell \leq n$  such that  $v_k v_\ell \notin A(D^*)$ , if  $|[p]^{v_k v_\ell}|$  is even then the arc  $v_k v_\ell$  is added to  $A(T)$ , and if  $|[p]^{v_k v_\ell}|$  is odd then the arc  $v_\ell v_k$  is added to  $A(T)$ . Note that in the first case,  $v_k v_\ell$  is reversed an even number of times by  $(X_i)_{i \in [p]}$ , and in the second  $v_\ell v_k$  is reversed an odd number of times by  $(X_i)_{i \in [p]}$ . Thus,

in both cases,  $v_k v_\ell \in A(\text{Inv}(T; (X_i)_{i \in [p]}))$ . Consequently,  $(v_1, \dots, v_n)$  is also an acyclic ordering of  $\text{Inv}(T; (X_i)_{i \in [p]})$ . Hence  $\text{inv}(T) \leq \text{inv}(D)$ , and so, by Proposition 3.2.1,  $\text{inv}(T) = \text{inv}(D)$ .  $\square$

### 3.2.1 Maximum inversion number of an oriented graph of order $n$

Given an oriented graph  $D$ , it might be interesting to determine an upper bound for the inversion number of  $D$  based on its order. For any positive integer  $n$ , let  $\text{inv}(n) = \max\{\text{inv}(D) \mid D \text{ oriented graph of order } n\}$ . That is,  $\text{inv}(n)$  is the largest inversion number of an oriented graph with  $n$  vertices. Since the inversion number is monotone (see Proposition 3.2.1) and every oriented graph is a subdigraph of some tournament, we can determine  $\text{inv}(n)$  considering only tournaments. So, we can rewrite  $\text{inv}(n) = \max\{\text{inv}(T) \mid T \text{ tournament of order } n\}$ .

**Proposition 3.2.5** (Belkhechine et al. (BELKHECHINE *et al.*, )),  $\text{inv}(n) \leq \text{inv}(n-1) + 1$  for all positive integer  $n$ .

*Proof.* Let  $T$  be a tournament of order  $n$ . Pick a vertex  $x$  of  $T$ . It is a sink in  $D' = \text{Inv}(T; N^+[x])$ . So  $\text{inv}(D') = \text{inv}(D' - x) \leq \text{inv}(n-1)$  by Lemma 3.2.2. Hence  $\text{inv}(T) \leq \text{inv}(n-1) + 1$ .  $\square$

Every oriented graph on at most two vertices is acyclic, so  $\text{inv}(1) = \text{inv}(2) = 0$ . Since in a tournament of order at most 4 there are no disjoint cycles, we can always find a vertex  $v$  intercepting all of its cycles. Moreover,  $\min\{d^-(v), d^+(v)\} = 1$  and we can break all cycles by turning  $v$  into a source or a sink using one inversion. Thus,  $\text{inv}(3) = \text{inv}(4) = 1$ . As observed by Belkhechine et al. (BELKHECHINE *et al.*, ), every tournament of order at most 6 has inversion number at most 2. Along with Proposition 3.2.5, those results imply the following:

**Corollary 3.2.6.**  $\text{inv}(n) \leq n - 4$  for all  $n \geq 6$ .

On the other side, Belkhechine et al. (BELKHECHINE *et al.*, 2010) also proved the next lower bound.

**Proposition 3.2.7** (Belkhechine et al. (BELKHECHINE *et al.*, 2010)).  $\text{inv}(n) \geq \frac{n-1}{2} - \log_2 n$  for all  $n$ .

However, it is believed that the bound provided in Proposition 3.2.7 is not tight.

**Conjecture 3.2.8** (Belkhechine et al. (BELKHECHINE *et al.*, )),  $\text{inv}(n) \geq \lfloor \frac{n-1}{2} \rfloor$ .

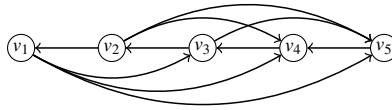

Figure 10 – A tournament  $Q_5$ .

Furthermore, some explicit tournaments have been conjectured to have inversion number at least  $\lfloor \frac{n-1}{2} \rfloor$ . Let  $Q_n$  be the tournament obtained from the transitive tournament by reversing the arcs of its unique directed hamiltonian path  $(v_1, v_2, \dots, v_n)$ . See Figure 10 for an example.

**Conjecture 3.2.9** (Belkhechine et al. (BELKHECHINE *et al.*, )).  $\text{inv}(Q_n) = \lfloor \frac{n-1}{2} \rfloor$ .

Is easy to see that  $\text{inv}(Q_n) \leq \lfloor \frac{n-1}{2} \rfloor$ , because, after inverting the set  $\{v_2, v_3\}$ , the vertex  $v_2$  becomes a source, and we only have to worry about the subtournament  $Q_n[v_3, \dots, v_n]$  which is isomorphic to  $Q_{n-2}$ . So, the challenge of proving Conjecture 3.2.9 lies in showing that  $\text{inv}(Q_n) \geq \lfloor \frac{n-1}{2} \rfloor$ . We put some effort into this matter and, in Section 3.7, we show that it holds for  $n \leq 7$ .

### 3.2.1.1 Computing $\text{inv}(n)$ for small values of $n$

There are  $2^{\frac{n(n-1)}{2}}$  tournaments of order  $n$  if we consider all the possibilities of orienting the  $\frac{n(n-1)}{2}$  edges of a complete graph. Nevertheless, many of these possible orientations are pairwise isomorphic and therefore with the same inversion number. So, to compute  $\text{inv}(n)$  by brute force, it is sufficient to obtain the inversion number of all non-isomorphic tournaments of order  $n$  and take the maximum. The number of non-isomorphic tournaments of order  $n$  corresponds to the “Number of outcomes of unlabeled  $n$ -team round-robin tournaments” found on the sequence A000568 from the website *The On-Line Encyclopedia of Integer Sequences* (OEIS®, ). We present the first 20 numbers of this sequence in the Table 1. This means that if  $\mathcal{T}^n$  is a set of pairwise non-isomorphic tournaments of order  $n$  and  $|\mathcal{T}^n| = a(n)$ , then for any tournament  $T$  with  $n$  vertices either  $T \in \mathcal{T}^n$  or  $T$  is isomorphic to some tournament in  $\mathcal{T}^n$ .

Using the library *networkx*<sup>1</sup> for python, we obtained by force the set  $\mathcal{T}^i$  for each  $i \leq 8$ . Then, we computed the inversion number of every tournament in  $\mathcal{T}^i$  allowing us to know the values  $\text{inv}(7)$  and  $\text{inv}(8)$  and also how the inversion numbers are distributed in each  $\mathcal{T}^i$  (Table

<sup>1</sup> <https://networkx.org/>

$n$	$a(n)$
0	1
1	1
2	1
3	2
4	4
5	12
6	56
7	456
8	6880
9	191536
10	9733056
11	903753248
12	154108311168
13	48542114686912
14	28401423719122304
15	31021002160355166848
16	63530415842308265100288
17	244912778438520759443245824
18	1783398846284777975419600287232
19	24605641171260376770598003978281472

Table 1 – The 20 first numbers of sequence A000568.

3). In Table 2, we have the values of  $\text{inv}(n)$  from  $n \leq 8$ . We recall that from  $n \leq 6$  these values was already known.

$n$	1	2	3	4	5	6	7	8
$\text{inv}(n)$	0	0	1	1	2	2	3	3

Table 2 – The values of  $\text{inv}(n)$ , for  $n \leq 8$ .

Observe that  $\text{inv}(8) = 3$  implies that  $\text{inv}(9) \leq 4$  by Proposition 3.2.5, and that Conjecture 3.2.9 holds for  $n = 8$ .

Inside  $\mathcal{T}^n$  there is only one tournament with inversion number 0, given that all acyclic tournaments are isomorphic. In Table 3, we show how many tournaments in  $\mathcal{T}^i$  have inversion number  $k$ , for each  $k \leq \text{inv}(i)$  and  $3 \leq i \leq 8$ .

### 3.3 Making a digraph acyclic: related problems

Making a digraph acyclic by either removing a minimum cardinality set of arcs or vertices are important and heavily studied problems, known under the names CYCLE ARC TRANSVERSAL or FEEDBACK ARC SET and CYCLE TRANSVERSAL or FEEDBACK VERTEX SET. A **cycle transversal** or **feedback vertex set** (resp. **cycle arc-transversal** or **feedback arc**

	Inversion number			
	0	1	2	3
$\mathcal{T}^3$	1	1	0	0
$\mathcal{T}^4$	1	3	0	0
$\mathcal{T}^5$	1	8	3	0
$\mathcal{T}^6$	1	22	33	0
$\mathcal{T}^7$	1	57	376	22
$\mathcal{T}^8$	1	141	3846	2892

Table 3 – The number of tournaments with inversion number  $k$  in each set  $\mathcal{T}^i$ , for every  $k \leq 3$  and  $3 \leq i \leq 8$ .

**set**) in a digraph is a set of vertices (resp. arcs) whose deletion results in an acyclic digraph. For an example, consider the digraph depicted in Figure 11. The set  $\{d\}$  is clearly a cycle transversal since the vertex  $d$  belongs to every cycle. We also have that the set  $\{ad, de\}$  is a cycle arc-transversal.

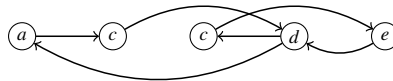

Figure 11 – Example of oriented graph.

For a digraph  $D$  we trivially have that the sets  $V(D)$  and  $A(D)$  are cycle transversal and cycle arc-transversal respectively. So, we actually are interested in non trivial sets of vertices and arcs and, most of the time, the minimum sets. The **cycle transversal number** (resp. **cycle arc-transversal number**) is the minimum size of a cycle transversal (resp. cycle arc-transversal) of  $D$  and is denoted by  $\tau(D)$  (resp.  $\tau'(D)$ ).

It is well-known that a digraph is acyclic if and only if it admits an **acyclic ordering**, that is an ordering  $(v_1, \dots, v_n)$  of its vertices such that there is no **backward** arc (i.e. an arc  $v_j v_i$  with  $i < j$ ). It follows that a minimum cycle arc-transversal  $F$  in a digraph  $D$  consists only of backward arcs with respect to any acyclic ordering of  $D \setminus F$ . Thus the digraph  $D'$  obtained from  $D$  by reversing the arcs of  $F$  is also acyclic. Conversely, if the digraph  $D'$  obtained from  $D$  by reversing the arcs of  $F$  is acyclic, then  $D \setminus F$  is also trivially acyclic. Therefore the cycle arc-transversal number of a digraph is also the minimum size of a set of arcs whose reversal makes the digraph acyclic.

It is well-known and easy to show that  $\tau(D) \leq \tau'(D)$  (just take one end-vertex of

each arc in a minimum cycle arc-transversal).

Computing  $\tau(D)$  and  $\tau'(D)$  are two of the first problems shown to be NP-hard listed by Karp in (KARP, 1972). They also remain NP-complete in tournaments as shown by Bang-Jensen and Thomassen (BANG-JENSEN; THOMASSEN, 1992) and Speckenmeyer (SPECKENMEYER, 1989) for  $\tau$ , and by Alon (ALON, 2006) and Charbit, Thomassé, and Yeo (CHARBIT *et al.*, 2007) for  $\tau'$ .

### 3.4 Inversion versus cycle (arc-) transversal and cycle packing

In this section we establish some relations between the inversion number of oriented graphs and other parameters starting with the following upper bounds in terms of the cycle transversal number and the cycle arc-transversal number.

**Theorem 3.4.1.**  $\text{inv}(D) \leq \tau'(D)$  and  $\text{inv}(D) \leq 2\tau(D)$  for all oriented graph  $D$ .

*Proof.* Observe that, as we mentioned before, if  $F$  is a minimum cycle arc-transversal, reversing the arcs of  $F$  results in an acyclic digraph. Thus, if  $F$  is a minimum cycle arc-transversal of an oriented graph  $D$ , then the family of sets of end-vertices of arcs of  $F$  is a decycling family of  $D$ . In other words,  $\text{Inv}(D; (X_a)_{a \in F})$  is acyclic, where  $X_a = \{u, v\}$ , for  $a = uv \in F$ . So  $\text{inv}(D) \leq \tau'(D)$ . Let  $S = \{x_1, \dots, x_k\}$  be a cycle transversal with  $k = \tau(D)$ . Lemma 3.2.3 and a direct induction imply  $\text{inv}(D) \leq \text{inv}(D - \{x_1, \dots, x_i\}) + 2i$  for all  $i \in [k]$ . Hence  $\text{inv}(D) \leq \text{inv}(D - S) + 2k$ . But, since  $S$  is a cycle transversal,  $D - S$  is acyclic, so  $\text{inv}(D - S) = 0$ . Hence  $\text{inv}(D) \leq 2k = 2\tau(D)$ .  $\square$

The question that immediately follows regards the tightness of these bounds. There are oriented graphs on which the equalities of Theorem 3.4.1 are reached? To answer that we need a few more definitions.

We denote by  $\vec{C}_3$  the directed cycle of length 3 and by  $TT_n$  the transitive tournament of order  $n$ . The vertices of  $TT_n$  are  $v_1, \dots, v_n$  and its arcs  $\{v_i v_j \mid i < j\}$ . The **lexicographic product** of a digraph  $D$  by a digraph  $H$  is the digraph  $D[H]$  with vertex set  $V(D) \times V(H)$  and arc set  $A(D[H]) = \{(a, x)(b, y) \mid ab \in A(D), \text{ or } a = b \text{ and } xy \in A(H)\}$ . It can be seen as blowing up each vertex of  $D$  by a copy of  $H$ . See Figure 12.

Using boolean dimension, Pouzet *et al.* (POUZET *et al.*, 2021) found the inversion number of  $TT_n[\vec{C}_3]$ .

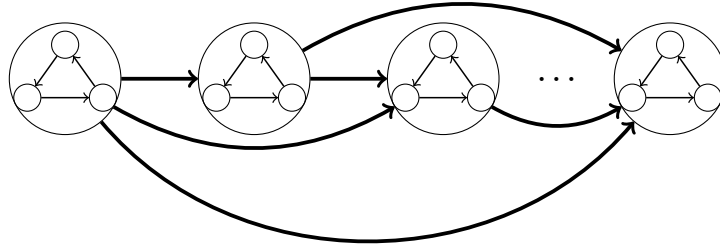

Figure 12 – Representation of the lexicographic product of  $TT_n$  by  $\vec{C}_3$ . The arcs in bold from one circle to another represent all possible arcs from the vertices inside the first to the ones inside the second.

**Theorem 3.4.2** (Pouzet et al. (POUZET *et al.*, 2021)). *For all  $n \geq 1$ ,  $\text{inv}(TT_n[\vec{C}_3]) = n$ .*

Observe that if we remove one arc from every copy of  $\vec{C}_3$  in  $TT_n[\vec{C}_3]$ , we have an acyclic digraph. Since we must remove an arc from every copy of  $\vec{C}_3$  to obtain a cycle arc-transversal, we have that  $\tau'(TT_n[\vec{C}_3]) = n$  and this shows that the inequality  $\text{inv}(D) \leq \tau'(D)$  of Theorem 3.4.1 is tight.

Pouzet asked in private communication for an elementary proof of Theorem 3.4.2. Let  $L$  and  $R$  be two oriented graphs. The **dijoin** from  $L$  to  $R$  is the oriented graph, denoted by  $L \rightarrow R$ , obtained from the disjoint union of  $L$  and  $R$  by adding all arcs from  $L$  to  $R$ . Observe that  $TT_n[\vec{C}_3] = \vec{C}_3 \rightarrow TT_{n-1}[\vec{C}_3]$ . So an elementary way to prove Theorem 3.4.2 would be to prove that  $\text{inv}(\vec{C}_3 \rightarrow T) = \text{inv}(T) + 1$  for all tournament  $T$ .

First inverting  $\text{inv}(L)$  subsets of  $V(L)$  to make  $L$  acyclic and then inverting  $\text{inv}(R)$  subsets of  $V(R)$  to make  $R$  acyclic, makes  $L \rightarrow R$  acyclic. Therefore we have the following inequality.

**Proposition 3.4.3.**  $\text{inv}(L \rightarrow R) \leq \text{inv}(L) + \text{inv}(R)$ .

In fact, we believe that equality always holds.

**Conjecture 3.4.4.** *For any two oriented graphs,  $L$  and  $R$ ,  $\text{inv}(L \rightarrow R) = \text{inv}(L) + \text{inv}(R)$ .*

We can prove that this conjecture is equivalent to its restriction to tournaments meaning that we can look for counterexamples to it inside the class of tournaments.

**Proposition 3.4.5.** *Conjecture 3.4.4 is equivalent to its restriction to tournaments.*

*Proof.* Suppose there are oriented graphs  $L, R$  that form a counterexample to Conjecture 3.4.4, that is, such that  $\text{inv}(L \rightarrow R) < \text{inv}(L) + \text{inv}(R)$ . By Lemma 3.2.4, there is an extension  $T$  of  $L \rightarrow R$  such that  $\text{inv}(T) = \text{inv}(L \rightarrow R)$  and let  $T_L = T \langle V(L) \rangle$  and  $T_R = T \langle V(R) \rangle$ . We have  $T = T_L \rightarrow T_R$  and by Proposition 3.2.1,  $\text{inv}(L) \leq \text{inv}(T_L)$  and  $\text{inv}(R) \leq \text{inv}(T_R)$ . Hence  $\text{inv}(T) < \text{inv}(T_L) + \text{inv}(T_R)$ , so  $T_L$  and  $T_R$  are two tournaments that form a counterexample to Conjecture 3.4.4.  $\square$

If  $\text{inv}(L) = 0$  (resp.  $\text{inv}(R) = 0$ ), then Conjecture 3.4.4 holds since any decycling family of  $R$  (resp.  $L$ ) is also a decycling family of  $L \rightarrow R$ . In Section 3.6, we prove Conjecture 3.4.4 when  $\text{inv}(L) = 1$  and  $\text{inv}(R) \in \{1, 2\}$ . We also prove it when  $\text{inv}(L) = \text{inv}(R) = 2$  and both  $L$  and  $R$  are strongly connected.

Let us now consider the inequality  $\text{inv}(D) \leq 2\tau(D)$  of Theorem 3.4.1. One can see that is tight for  $\tau(D) = 1$ . Indeed, let  $V_n$  be the tournament obtained from a  $TT_{n-1}$  by adding a vertex  $x$  such that  $N^+(x) = \{v_i \mid i \text{ is odd}\}$  and so  $N^-(x) = \{v_i \mid i \text{ is even}\}$ . Clearly,  $\tau(V_n) = 1$  because  $V_n - x$  is acyclic, and one can easily check that  $\text{inv}(V_n) \geq 2$  for  $n \geq 5$ . Observe that  $V_5$  is strong (See Figure 14 for an example of  $V_5$  with  $x = v_5$ ), so by the above results, we have  $\text{inv}(V_5 \rightarrow V_5) = 4$  while  $\tau(V_5 \rightarrow V_5) = 2$ , so the inequality  $\text{inv}(D) \leq 2\tau(D)$  is also tight for  $\tau(D) = 2$ . More generally, Conjecture 3.4.4 would imply that  $\text{inv}(TT_n[V_5]) = 2n$ , while  $\tau(TT_n[V_5]) = n$  and thus that the second inequality of Theorem 3.4.1 is tight. Hence we conjecture the following.

**Conjecture 3.4.6.** *For every positive integer  $n$ , there exists an oriented graph  $D$  such that  $\tau(D) = n$  and  $\text{inv}(D) = 2n$ .*

A **cycle packing** in a digraph is a set of vertex disjoint cycles. The **cycle packing number** of a digraph  $D$ , denoted by  $\nu(D)$ , is the maximum size of a cycle packing in  $D$ . We have  $\nu(D) \leq \tau(D)$  for every digraph  $D$ . On the other hand, Reed et al. (REED *et al.*, 1996) proved that there is a (minimum) function  $f$  such that  $\tau(D) \leq f(\nu(D))$  for every digraph  $D$ . With Theorem 3.4.1, this implies  $\text{inv}(D) \leq 2 \cdot f(\nu(D))$ .

**Theorem 3.4.7.** *There is a (minimum) function  $g$  such that  $\text{inv}(D) \leq g(\nu(D))$  for all oriented graph  $D$  and  $g \leq 2f$ .*

A natural question is then to determine this function  $g$  or at least obtain good upper bounds on it. Note that the upper bound on  $f$  given by the proof of Reed et al. (REED *et al.*, 1996) is huge (a multiply iterated exponential, where the number of iterations is also a multiply



iterated exponential). The only known value has been established by McCuaig (MCCUAIG, 1991) who proved  $f(1) = 3$ . As noted in (REED *et al.*, 1996), the best lower bound on  $f$  due to Alon (unpublished) is  $f(k) \geq k \log k$ . It might be that  $f(k) = O(k \log k)$ . This would imply the following conjecture.

**Conjecture 3.4.8.** *For all  $k$ ,  $g(k) = O(k \log k)$ : there is an absolute constant  $C$  such that  $\text{inv}(D) \leq C \cdot v(D) \log(v(D))$  for all oriented graph  $D$ .*

Note that for planar digraphs, combining results of Reed and Sheperd (REED; SHEPHERD, 1996) and Goemans and Williamson (GOEMANS; WILLIAMSON, 1996), we get  $\tau(D) \leq 63 \cdot v(D)$  for every planar digraph  $D$ . This implies that  $\tau(D) \leq 126 \cdot v(D)$  for every planar digraph  $D$  and so Conjecture 3.4.8 holds for planar oriented graphs.

Another natural question is whether the inequality  $g \leq 2f$  is tight. In Section 3.8, we show that it is not the case. We show that  $g(1) \leq 4$ , while  $f(1) = 3$  as shown by McCuaig (MCCUAIG, 1991). However, we do not know if this bound 4 on  $g(1)$  is attained.

In contrast to Theorems 3.4.1 and 3.4.7, the difference between  $\text{inv}$  and  $v$ ,  $\tau$ , and  $\tau'$  can be arbitrarily large as for every  $k$ , there are tournaments  $T_k$  for which  $\text{inv}(T_k) = 1$  and  $v(T_k) = k$ . Consider for example the tournament  $T_k$  obtained from three transitive tournaments  $A, B, C$  of order  $k$  by adding all arcs from  $A$  to  $B$ ,  $B$  to  $C$  and  $C$  to  $A$ . See Figure 13 for an example with  $k = 3$ . One easily sees that  $v(T_k) = k$  and so  $\tau'(T_k) \geq \tau(T_k) \geq k$ ; moreover  $\text{Inv}(T_k; A \cup B)$  is a transitive tournament, so  $\text{inv}(T_k) = 1$ .

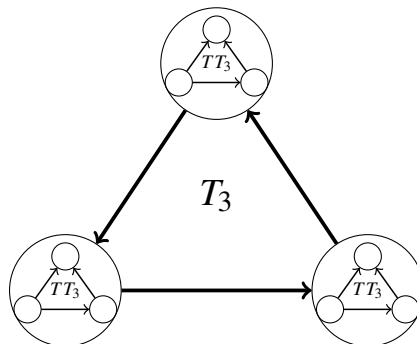

Figure 13 – Representation of  $T_3$ , where inversion number is 1 but cycle packing number is 3.

### 3.5 Computing the inversion number of an oriented graph

In Section 3.2 we presented a simple algorithm (Algorithm 2) which outputs a decycling family of an oriented graph. We also commented that this algorithm is very far from optimal because the size of the decycling family it returns can be much bigger than the inversion number of the oriented graph of the input. So we consider the complexity of computing the inversion number of an oriented graph and the following associated problem.

$k$ -INVERSION.

Input: An oriented graph  $D$ .

Question:  $\text{inv}(D) \leq k$  ?

We also study the complexity of the restriction of this problem to tournaments.

$k$ -TOURNAMENT-INVERSION.

Input: A tournament  $T$ .

Question:  $\text{inv}(T) \leq k$  ?

Note that 0-INVERSION is equivalent to deciding whether an oriented graph  $D$  is acyclic. This can be done in  $O(|V(D)| + |A(D)|)$  time.

Let  $k$  be a positive integer. A tournament  $T$  is  **$k$ -inversion-critical** if  $\text{inv}(T) = k$  and  $\text{inv}(T - v) < k$  for all  $v \in V(T)$ . We denote by  $\mathcal{IC}_k$  the set of  $k$ -inversion-critical tournaments.

**Theorem 3.5.1** (Belkhechine *et al.* (2010)). *For any positive integer  $k$ , the set  $\mathcal{IC}_k$  is finite.*

Recall that we refer to an induced subgraph of a tournament using the term subtournament. From the above and following results, it follows that there is a limited number of forbidden subtournaments for a tournament with inversion number at most  $k$ .

**Lemma 3.5.2.** *A tournament  $T$  has inversion number greater than  $k$  if and only if  $T$  has a subtournament in  $\mathcal{IC}_{k+1} \cup \mathcal{IC}_{k+2}$ .*

*Proof.* The necessity is trivial. Assuming that  $\text{inv}(T) > k$ , we first argue that  $T$  has a subtournament  $T'$  with  $\text{inv}(T') \in \{k+1, k+2\}$ . By Lemma 3.2.3, we have that  $\text{inv}(T - v) \in \{\text{inv}(T), \text{inv}(T) - 1, \text{inv}(T) - 2\}$  for every  $v \in V(T)$ . Thus, there is a set  $S \subset V(T)$  such that  $\text{inv}(T - S) \in \{k+1, k+2\}$ . Let  $T' = T - S$ , if  $T' \notin \mathcal{IC}_{k+1} \cup \mathcal{IC}_{k+2}$ , then there is a vertex  $w$  such that  $\text{inv}(T' - w) = \text{inv}(T')$ . Similarly, there exists a set  $S' \subset V(T')$  such that  $\text{inv}(T' - S') = \text{inv}(T')$  and if  $S'$  is a maximal set with this property, then  $T' - S' \in \mathcal{IC}_{k+1} \cup \mathcal{IC}_{k+2}$ .  $\square$

By checking whether the given tournament  $T$  contains  $I$  for every element  $I$  in  $\mathcal{IC}_{k+1} \cup \mathcal{IC}_{k+2}$ , one can decide whether  $\text{inv}(T) > k$  in  $O(|V(T)|^{\max\{m_{k+1}, m_{k+2}\}})$  time, where  $m_k$  is the maximum order of an element of  $\mathcal{IC}_k$ .

**Corollary 3.5.3.** *For any non-negative fixed integer  $k$ ,  $k$ -TOURNAMENT-INVERSION is polynomial-time solvable.*

The proof of Theorem 3.5.1 neither explicitly describes  $\mathcal{IC}_k$  nor gives upper bound on  $m_k$ . So the degree of the polynomial in Corollary 3.5.3 is unknown. This leaves open the following questions.

**Problem 3.5.4.** *Explicitly describe  $\mathcal{IC}_k$  or at least find an upper bound on  $m_k$ .*

*What is the minimum real number  $r_k$  such that  $k$ -TOURNAMENT-INVERSION can be solved in  $O(|V(T)|^{r_k})$  time?*

As observed in (BELKHECHINE *et al.*, 2010),  $\mathcal{IC}_1 = \{\vec{C}_3\}$ , so  $m_1 = 3$ . This implies that 0-TOURNAMENT-INVERSION can be done in  $O(n^3)$ . However, deciding whether a tournament is acyclic can be solved in  $O(n^2)$ -time. Belkhechine *et al.* (BELKHECHINE *et al.*, 2010) also proved that  $\mathcal{IC}_2 = \{A_6, B_6, D_5, R_5, V_5\}$  where:

- $A_6 = TT_2[\vec{C}_3] = \text{Inv}(TT_6; (\{v_1, v_3\}, \{v_4, v_6\}))$ ;
- $B_6 = \text{Inv}(TT_6; (\{v_1, v_4, v_5\}, \{v_2, v_5, v_6\}))$ ;
- $D_5 = \text{Inv}(TT_5; (\{v_2, v_4\}, \{v_1, v_5\}))$ ;
- $R_5 = \text{Inv}(TT_5; (\{v_1, v_3, v_5\}, \{v_2, v_4\}))$ ;
- and  $V_5 = \text{Inv}(TT_5; (\{v_1, v_5\}, \{v_3, v_5\}))$ .

See Figure 14.

Hence,  $m_2 = 6$ . Since the small tournaments to have inversion number 3 have order 7 (see Table 2), we have that  $m_3 \geq 7$  and therefore the polynomial degree of the implicit algorithm of Corollary 3.5.3 for 1-TOURNAMENT-INVERSION is at least 7. This is not optimal: we show in Subsection 3.9.2 that it can be solved in  $O(n^3)$ -time, and that 2-TOURNAMENT-INVERSION can be solved in  $O(n^6)$ -time.

There is no upper bound on  $m_k$  so far. Hence since the inversion number of a tournament can be linear in its order (See e.g. tournament  $T_k$  described in Section 3.4 and Figure 13), Theorem 3.5.1 does not imply that one can compute the inversion number of a tournament in polynomial time because it is restricted to the case where  $k$  is not part of the input. In fact, we believe that it cannot be calculated in polynomial time.

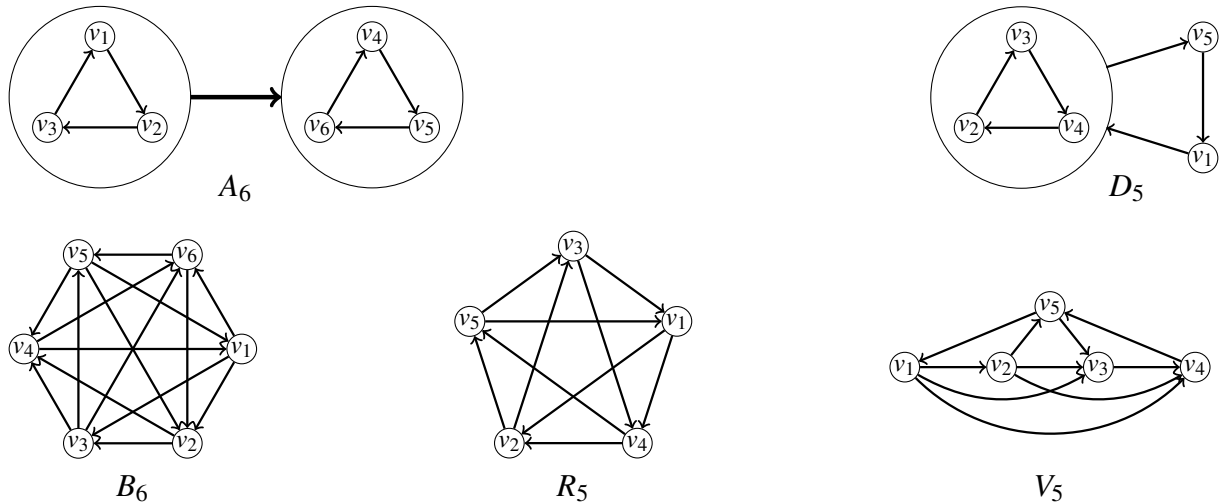

Figure 14 – The 2-inversion-critical tournaments (Source: (BANG-JENSEN *et al.*, 2022)).

**Conjecture 3.5.5.** *Given a tournament and an integer  $k$ , deciding whether  $\text{inv}(T) = k$  is NP-complete.*

In contrast to Corollary 3.5.3, we show in Subsection 3.9.1 that 1-INVERSION is NP-complete. Note that together with Conjecture 3.4.4, this would imply that  $k$ -INVERSION is NP-complete for every positive integer  $k$ . Because, assuming Conjecture 3.4.4 is true, we could take  $L$  as an instance of 1-INVERSION and  $R$  as any oriented graph with  $\text{inv}(R) = k - 1$ , then we would have that  $\text{inv}(L \rightarrow R) = k$  if and only if  $\text{inv}(L) = 1$ .

**Conjecture 3.5.6.**  *$k$ -INVERSION is NP-complete for all positive integer  $k$ .*

Since we have proved Conjecture 3.4.4 for  $\text{inv}(L) = \text{inv}(R) = 1$ , we also have that 2-INVERSION is NP-complete.

Because of its relations with  $\tau'$ ,  $\tau$ , and  $\nu$ , (see Section 3.4), it is natural to ask about the complexity of computing the inversion number when restricted to oriented graphs (tournaments) for which one of these parameters is bounded. Recall that  $\text{inv}(D) = 0$  if and only if  $D$  is acyclic, so if and only if  $\tau'(D) = \tau(D) = \nu(D) = 0$ .

**Problem 3.5.7.** *Let  $k$  be a positive integer and  $\gamma$  be a parameter in  $\{\tau', \tau, \nu\}$ . What is the complexity of computing the inversion number of an oriented graph (tournament)  $D$  with  $\gamma(D) \leq k$ ?*

Conversely, it is also natural to ask about the complexity of computing any of  $\tau'$ ,  $\tau$ , and  $\nu$ , when restricted to oriented graphs with bounded inversion number. In Subsection 3.9.3,

we show that computing any of these parameters is NP-hard even for oriented graphs with inversion number 1. However, the question remains open when we restrict to tournaments.

**Problem 3.5.8.** *Let  $k$  be a positive integer and  $\gamma$  be a parameter in  $\{\tau', \tau, \nu\}$ . What is the complexity of computing  $\gamma(T)$  for a tournament  $T$  with  $\text{inv}(T) \leq k$  ?*

### 3.6 Inversion number of dijoins of oriented graphs

In this section, we give some evidence for the following conjecture which was first presented in Section 3.4. We prove that it holds when  $\text{inv}(L)$  and  $\text{inv}(R)$  are small.

**Conjecture 3.4.4.** *For any two oriented graphs  $L$  and  $R$ ,  $\text{inv}(L \rightarrow R) = \text{inv}(L) + \text{inv}(R)$ .*

We start with the following result that is useful to the other proofs.

**Proposition 3.6.1.** *Let  $L$  and  $R$  be two oriented graphs. If  $\text{inv}(L), \text{inv}(R) \geq 1$ , then  $\text{inv}(L \rightarrow R) \geq 2$ .*

*Proof.* Assume  $\text{inv}(L), \text{inv}(R) \geq 1$ . Then  $L$  and  $R$  are not acyclic, so let  $C_L$  and  $C_R$  be directed cycles in  $L$  and  $R$  respectively. Assume for a contradiction that there is a set  $X$  such that inverting  $X$  in  $L \rightarrow R$  results in an acyclic digraph  $D'$ . There must be an arc  $xy$  in  $A(C_L)$  such that  $x \in X$  and  $y \notin X$ , and there must be  $z \in X \cap V(C_R)$ . But then  $(x, y, z, x)$  is a directed cycle in  $D'$ , a contradiction.  $\square$

Propositions 3.4.3 and 3.6.1 directly imply that Conjecture 3.4.4 holds when  $\text{inv}(L) = \text{inv}(R) = 1$ .

**Corollary 3.6.2.** *Let  $L$  and  $R$  be two oriented graphs. If  $\text{inv}(L) = \text{inv}(R) = 1$ , then  $\text{inv}(L \rightarrow R) = 2$ .*

Further than Proposition 3.6.1, the following result gives some property of a minimum decycling family of  $L \rightarrow R$  when  $\text{inv}(L) = \text{inv}(R) = 1$ .

**Theorem 3.6.3.** *Let  $D = (L \rightarrow R)$ , where  $L$  and  $R$  are two oriented graphs with  $\text{inv}(L) = \text{inv}(R) = 1$ . Then, for any decycling family  $(X_1, X_2)$  of  $D$ , either  $X_1 \subset V(L), X_2 \subset V(R)$  or  $X_1 \subset V(R), X_2 \subset V(L)$ .*

*Proof.* Let  $(X_1, X_2)$  be a decycling family of  $D$  and let  $D^*$  be the acyclic digraph obtained after inverting  $X_1$  and  $X_2$  (in symbols  $D^* = \text{Inv}(D; (X_1, X_2))$ ).

Let us define some sets. See Figure 15.

- For  $i \in [2]$ ,  $X_i^L = X_i \cap V(L)$  and  $X_i^R = X_i \cap V(R)$ .
- $Z^L = V(L) \setminus (X_1^L \cup X_2^L)$  and  $Z^R = V(R) \setminus (X_1^R \cup X_2^R)$ .
- $X_{12}^L = X_1^L \cap X_2^L$  and  $X_{12}^R = X_1^R \cap X_2^R$ .
- for  $\{i, j\} = \{1, 2\}$ ,  $X_{i-j}^L = (X_i^L \setminus X_j^L)$  and  $X_{i-j}^R = (X_i^R \setminus X_j^R)$ .

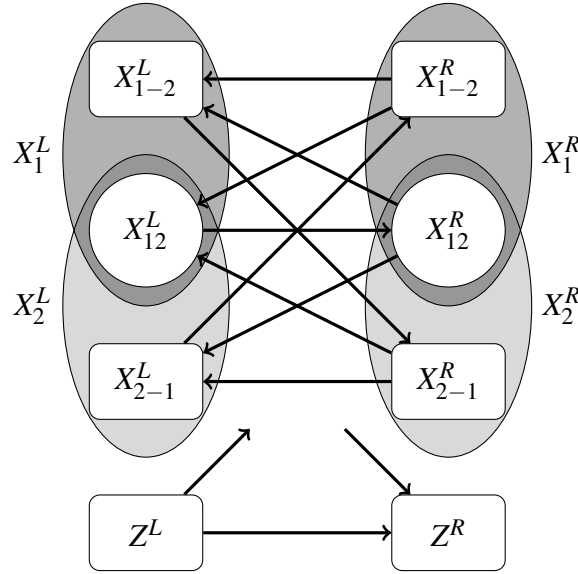

Figure 15 – The oriented graph  $D^*$  (Source: (BANG-JENSEN *et al.*, 2022)).

Observe that at least one of the sets  $X_{1-2}^L, X_{2-1}^R, X_{2-1}^L$  and  $X_{1-2}^R$  must be empty, otherwise  $D^*$  is not acyclic. By symmetry, we may assume that it is  $X_{1-2}^R$  or  $X_{2-1}^R$ . Observe moreover that  $X_{1-2}^R \cup X_{2-1}^R \neq \emptyset$  for otherwise  $X_1^R = X_2^R = X_{12}^R$ , meaning that every arc in  $R$  was inverted twice and so  $D^*\langle V(R) \rangle = R$  is not acyclic.

Assume first that  $X_{1-2}^R = \emptyset$  and so  $X_{2-1}^R \neq \emptyset$ .

Suppose for a contradiction that  $X_{12}^R \neq \emptyset$  and let  $a \in X_{2-1}^R, b \in X_{12}^R$ . Let  $C$  be a directed cycle in  $L$ . Note that  $V(C)$  cannot be contained in one of the sets  $X_{1-2}^L, X_{12}^L, X_{2-1}^L$  or  $Z^L$ . If  $V(C) \cap Z^L \neq \emptyset$ , there is an arc  $cd \in A(L)$  such that  $c \in X_{1-2}^L \cup X_{12}^L \cup X_{2-1}^L$  and  $d \in Z^L$ . Then, either  $(c, d, a, c)$  or  $(c, d, b, c)$  is a directed cycle in  $D^*$ , a contradiction. Thus,  $V(C) \subseteq X_{1-2}^L \cup X_{12}^L \cup X_{2-1}^L$ . If  $V(C) \cap X_{12}^L \neq \emptyset$ , then there is an arc  $cd \in A(L)$  such that  $c \in X_{12}^L$  and  $d \in X_{1-2}^L \cup X_{2-1}^L$  which means that  $dc \in A(D^*)$  and  $(d, c, b, d)$  is a directed cycle in  $D^*$ , a contradiction. Hence  $V(C) \subseteq X_{1-2}^L \cup X_{2-1}^L$  and there exists an arc  $cd \in A(L)$  such that  $c \in X_{2-1}^L, d \in X_{1-2}^L$  and  $(c, d, a, c)$  is a directed cycle in  $D^*$ , a contradiction.

Therefore  $X_{12}^R = \emptyset$  and every directed cycle of  $R$  has its vertices in  $X_{2-1}^R \cup Z^R$ . Then,

there is an arc  $ea \in A(R)$  with  $a \in X_{2-1}^R$  and  $e \in Z^R$ . Note that, in this case,  $ea \in A(D^*)$  and  $(e, a, c, e)$  is a directed cycle in  $D^*$  for any  $c \in X_{12}^L \cup X_{2-1}^L$ . Thus,  $X_{12}^L = X_{2-1}^L = \emptyset$  and  $X_1 \subset V(L), X_2 \subset V(R)$ .

If  $X_{2-1}^R = \emptyset$ , we can symmetrically apply the same arguments to conclude that  $X_1 \subset V(R)$  and  $X_2 \subset V(L)$ .  $\square$

**Theorem 3.6.4.** *Let  $L$  and  $R$  be two oriented graphs. If  $\text{inv}(L) = 1$  and  $\text{inv}(R) = 2$ , then  $\text{inv}(L \rightarrow R) = 3$ .*

*Proof.* Let  $D = (L \rightarrow R)$ . By Propositions 3.4.3 and 3.6.1, we know that  $2 \leq \text{inv}(D) \leq 3$ .

Assume for a contradiction that  $\text{inv}(D) = 2$ . Let  $(X_1, X_2)$  be a decycling family of  $D$  and let  $D^* = \text{Inv}(D; (X_1, X_2))$ . Let  $L^* = D^* \langle V(L) \rangle$  and  $R^* = D^* \langle V(R) \rangle$ . We define the sets  $X_1^L, X_2^L, X_1^R, X_2^R, Z^L, Z^R, X_{12}^L, X_{12}^R, X_{1-2}^L, X_{2-1}^L, X_{1-2}^R$ , and  $X_{2-1}^R$  as in Theorem 3.6.3. See Figure 15. Note that each of these sets induces an acyclic digraph in  $D^*$  and thus also in  $D$ . For  $i \in [2]$ , let  $D_i = \text{Inv}(D; X_i)$ , let  $L_i = \text{Inv}(L, X_i^L) = \text{Inv}(L^*; X_{j-i}^L)$  where  $\{j\} = [2] \setminus \{i\}$ , and  $R_i = \text{Inv}(R, X_i^R) = \text{Inv}(R^*; X_{j-i}^R)$  where  $\{j\} = [2] \setminus \{i\}$ . Since  $\text{inv}(D) = 2$ ,  $\text{inv}(D_1) = \text{inv}(D_2) = 1$ . Since  $\text{inv}(R) = 2$ ,  $R_1$  and  $R_2$  are both non-acyclic, so  $\text{inv}(R_1) = \text{inv}(R_2) = 1$ .

**Claim 1:**  $X_i^L, X_i^R \neq \emptyset$  for all  $i \in [2]$ .

*Proof.* Since  $\text{inv}(R) = 2$ , necessarily,  $X_1^R, X_2^R \neq \emptyset$ .

Suppose now that  $X_i^L = \emptyset$  for some  $i \in [2]$ . Then  $D_i = L \rightarrow R_i$ . As  $\text{inv}(L) \geq 1$  and  $\text{inv}(R_i) \geq 1$ , by Proposition 3.6.1  $\text{inv}(D_i) \geq 2$ , a contradiction.  $\diamond$

**Claim 2:**  $X_1^L \neq X_2^L$  and  $X_1^R \neq X_2^R$ .

*Proof.* If  $X_1^L = X_2^L$ , then  $L^* = L$ , so  $L^*$  is not acyclic, a contradiction. Similarly, If  $X_1^R = X_2^R$ , then  $R^* = R$ , so  $R^*$  is not acyclic, a contradiction.  $\diamond$

In particular, Claim 2 implies that  $X_{1-2}^L \cup X_{2-1}^L \neq \emptyset$ .

In the following, we denote by  $A \rightsquigarrow B$  the fact that there is no arc from  $B$  to  $A$ .

Assume first that  $X_{1-2}^R = \emptyset$ . By Claim 1,  $X_1^R \neq \emptyset$ , so  $X_{12}^R \neq \emptyset$  and by Claim 2,  $X_1^R \neq X_2^R$ , so  $X_{2-1}^R \neq \emptyset$ .

If  $X_{2-1}^L \neq \emptyset$ , then, in  $D^*$ ,  $X_{2-1}^R \cup X_{12}^R \rightsquigarrow Z^R$  because  $X_{2-1}^R \cup X_{12}^R \rightarrow X_{2-1}^L \rightarrow Z^R$ . But then  $R_1 = \text{Inv}(R^*; X_2^R)$  would be acyclic, a contradiction. Thus,  $X_{2-1}^L = \emptyset$ .

Then by Claims 1 and 2, we get  $X_{12}^L, X_{1-2}^L \neq \emptyset$ . Hence, as  $X_{12}^R \rightarrow X_{1-2}^L \rightarrow X_{2-1}^R \rightarrow X_{12}^L \rightarrow X_{12}^R$  in  $D^*$ , there is a directed cycle in  $D^*$ , a contradiction. Therefore  $X_{1-2}^R \neq \emptyset$ .

In the same way, one shows that  $X_{2-1}^R \neq \emptyset$ . As  $X_{1-2}^R \rightarrow X_{1-2}^L \rightarrow X_{2-1}^R \rightarrow X_{2-1}^L \rightarrow X_{1-2}^R$  in  $D^*$ , and  $D^*$  is acyclic, one of  $X_{1-2}^L$  and  $X_{2-1}^L$  must be empty. Without loss of generality, we may assume  $X_{1-2}^L = \emptyset$ .

Then by Claims 1 and 2, we have  $X_{12}^L, X_{2-1}^L \neq \emptyset$ . Furthermore  $X_{12}^R = \emptyset$  because  $X_{12}^R \rightarrow X_{2-1}^L \rightarrow X_{1-2}^R \rightarrow X_{12}^L \rightarrow X_{12}^R$  in  $D^*$ . Now in  $D^*$ ,  $X_{2-1}^R \rightsquigarrow X_{1-2}^R \cup Z^R$  because  $X_{2-1}^R \rightarrow X_{2-1}^L \rightarrow X_{1-2}^R \cup Z^R$ , and  $X_{1-2}^R \rightsquigarrow Z^R$  because  $X_{1-2}^R \rightarrow X_{12}^L \rightarrow Z^R$ . Thus, in  $D$ , we also have  $X_{2-1}^R \rightsquigarrow X_{1-2}^R \cup Z^R$  and  $X_{1-2}^R \rightsquigarrow Z^R$ . So  $R$  is acyclic, a contradiction to  $\text{inv}(R) \geq 2$ .

Therefore  $\text{inv}(D) \geq 3$ . So  $\text{inv}(D) = 3$ . □

**Corollary 3.6.5.** *Let  $D$  be an oriented graph. Then  $\text{inv}(D) = 1$  if and only if  $\text{inv}(D \rightarrow D) = 2$ .*

*Proof.* Assume first that  $\text{inv}(D) = 1$ . Then by Corollary 3.6.2,  $\text{inv}(D \rightarrow D) = 2$ .

Assume now that  $\text{inv}(D) \neq 1$ .

If  $\text{inv}(D) = 0$ , then  $D$  is acyclic, and so is  $D \rightarrow D$ . Hence  $\text{inv}(D \rightarrow D) = 0$ .

If  $\text{inv}(D) \geq 3$ , then  $\text{inv}(D \rightarrow D) \geq \text{inv}(D)$  (by Proposition 3.2.1 because  $D$  is a subdigraph of  $D \rightarrow D$ ) and so  $\text{inv}(D \rightarrow D) \geq 3$ .

If  $\text{inv}(D) = 2$ , then  $D$  contains a directed cycle  $C$ . Now  $C \rightarrow D$  is a subdigraph of  $D \rightarrow D$ , so by Proposition 3.2.1  $\text{inv}(D \rightarrow D) \geq \text{inv}(C \rightarrow D)$ . Clearly,  $\text{inv}(C) = 1$ , thus, by Theorem 3.6.4,  $\text{inv}(C \rightarrow D) = 3$  and so  $\text{inv}(D \rightarrow D) \geq 3$ . □

### 3.6.1 Dijoin of oriented graphs with inversion number 2

**Theorem 3.6.6.** *Let  $L$  and  $R$  be strong oriented graphs such that  $\text{inv}(L), \text{inv}(R) \geq 2$ . Then  $\text{inv}(L \rightarrow R) \geq 4$ .*

*Proof.* Assume for a contradiction that there are two strong oriented graphs  $L$  and  $R$  such that  $\text{inv}(L), \text{inv}(R) \geq 2$  and  $\text{inv}(L \rightarrow R) \leq 3$ . By Lemma 3.2.4 and Proposition 3.2.1, we can assume that  $L$  and  $R$  are strong tournaments.

Hence  $L$  contains  $\vec{C}_3$ . By Theorem 3.6.4,  $\text{inv}(\vec{C}_3 \rightarrow R) \geq 3$ . But  $\vec{C}_3 \rightarrow R$  is a subtournament of  $L \rightarrow R$ . Thus, by Proposition 3.2.1,  $\text{inv}(L \rightarrow R) \geq 3$  and so  $\text{inv}(L \rightarrow R) = 3$ . Let  $(X_1, X_2, X_3)$  be a decycling sequence of  $D = L \rightarrow R$  and denote the resulting acyclic (transitive) tournament by  $T$ . We will use the following notation. Below and in the whole proof, whenever we use subscripts  $i, j, k$  together we have  $\{i, j, k\} = \{1, 2, 3\}$ .



- $X_i^L = X_i \cap V(L), X_i^R = X_i \cap V(R)$  for all  $i \in [3]$ .
- $Z^L = V(L) \setminus (X_1^L \cup X_2^L \cup X_3^L)$  and  $Z^R = V(R) \setminus (X_1^R \cup X_2^R \cup X_3^R)$ .
- $X_{123}^L = X_1^L \cap X_2^L \cap X_3^L, X_{123}^R = X_1^R \cap X_2^R \cap X_3^R$ .
- $X_{ij-k}^L = (X_i^L \cap X_j^L) \setminus X_k^L$  and  $X_{ij-k}^R = (X_i^R \cap X_j^R) \setminus X_k^R$ .
- $X_{i-jk}^L = X_i^L \setminus (X_j^L \cup X_k^L)$  and  $X_{i-jk}^R = X_i^R \setminus (X_j^R \cup X_k^R)$ .

For any two (possibly empty) sets  $Q, W$ , we write  $Q \rightarrow W$  to indicate that every  $q \in Q$  has an arc to every  $w \in W$ . Unless otherwise specified, we are always referring to the arcs of  $T$  below. When we refer to arcs of the original digraph we will use the notation  $u \Rightarrow v$ , whereas we use  $u \rightarrow v$  for arcs in  $T$ .

**Claim A:**  $X_i^L, X_i^R \neq \emptyset$  for all  $i \in [3]$ .

*Proof.* Suppose w.l.o.g. that  $X_1^R = \emptyset$  and let  $D' = \text{Inv}(D; X_1)$ . Then  $D'$  contains  $\vec{C}_3 \rightarrow R$  as a subtournament since reversing  $X_1^L$  does not make  $L$  acyclic so there is still a directed 3-cycle (by Moon's theorem).  $\diamond$

**Claim B:** In  $T$  the following holds, implying that at least one of the involved sets is empty (as  $T$  is acyclic).

$$(a) X_{123}^R \rightarrow X_{123}^L \rightarrow X_{ij-k}^R \rightarrow X_{ik-j}^L \rightarrow X_{123}^R.$$

$$(b) X_{ij-k}^L \rightarrow X_{ij-k}^R \rightarrow X_{ik-j}^L \rightarrow X_{ik-j}^R \rightarrow X_{ij-k}^L.$$

*Proof.* This follows from the fact that an arc of  $D$  is inverted if and only if it belongs to an odd number of the sets  $X_1, X_2, X_3$ .  $\diamond$

**Claim C:** For all  $i \neq j$ , we have  $X_i^L \neq X_j^L$  and  $X_i^R \neq X_j^R$ .

*Proof.* Suppose this is not true, then without loss of generality  $X_3^L = X_2^L$  but this contradicts that  $(X_1^L, X_2^L, X_3^L)$  is a decycling sequence of  $L$  as inverting  $X_2^L$  and  $X_3^L$  leaves every arc unchanged and we have  $\text{inv}(L) \geq 2$ .  $\diamond$

Now we are ready to obtain a contradiction to the assumption that  $(X_1, X_2, X_3)$  is a decycling sequence for  $D = L \rightarrow R$ . We divide the proof into five cases. In order to increase readability, we will emphasize partial conclusions in **blue**, assumptions in **orange**, and indicate consequences of assumptions in **red**.

**Case 1:**  $X_{i-jk}^L = \emptyset = X_{i-jk}^R$  for all  $i, j, k$ .

By Claim C, at least two of the sets  $X_{12-3}^L, X_{13-2}^L, X_{23-1}^L$  are non-empty and at least

two of the sets  $X_{12-3}^R, X_{13-2}^R, X_{23-1}^R$  are non-empty. Without loss of generality,  $X_{12-3}^L, X_{13-2}^L \neq \emptyset$ . Now Claim B (b) implies that one of  $X_{12-3}^R, X_{13-2}^R$  must be empty. By interchanging the names of  $X_2, X_3$  if necessary, we may assume that  $X_{13-2}^R = \emptyset$  and hence, by Claim C,  $X_{12-3}^R, X_{23-1}^R \neq \emptyset$ . By Claim B (a), this implies  $X_{23-1}^L = \emptyset$ . Now  $X_{23-1}^R \rightarrow X_{12-3}^L \rightarrow X_{12-3}^R$ , so  $X_{23-1}^R \rightarrow X_{13-2}^R$ . As  $X_{12-3}^L \rightarrow X_{12-3}^R \rightarrow X_{13-2}^L$ , we must have  $X_{12-3}^L \rightarrow X_{13-2}^L$ . By Claim B (a),  $X_{123}^L \rightarrow X_{12-3}^R \rightarrow X_{13-2}^L \rightarrow X_{123}^R \rightarrow X_{123}^L$ , so one of  $X_{123}^L$  and  $X_{123}^R$  is empty. W.l.o.g. we may assume  $X_{123}^R = \emptyset$ . As  $R$  is strong and  $X_{23-1}^R$  dominates  $X_{12-3}^R$  in  $R$  (these arcs are reversed by  $X_2$ ), we must have  $Z^R \neq \emptyset$ . Moreover the arcs incident to  $Z^R$  are not reversed, so the set  $Z^R$  has an out-neighbour in  $X_{12-3}^R \cup X_{23-1}^R$ . But  $X_{12-3}^R \cup X_{23-1}^R \rightarrow X_{13-2}^L \rightarrow Z^R$  so  $T$  has a directed 3-cycle, contradiction. This completes the proof of Case 1.

**Case 2:** Exactly one of  $X_{1-23}^L, X_{2-13}^L, X_{3-12}^L, X_{1-23}^R, X_{2-13}^R, X_{3-12}^R$  is non-empty.

By reversing all arcs and switching the names of  $L$  and  $R$  if necessary, we may assume w.l.o.g that  $X_{1-23}^L \neq \emptyset$ . As  $X_2^R \neq X_3^R$  we have  $X_{12-3}^R \cup X_{13-2}^R \neq \emptyset$ . By symmetry, we can assume that  $X_{12-3}^R \neq \emptyset$ .

Suppose for a contradiction that  $X_{23-1}^R = \emptyset$ . Then Claims A and C imply  $X_{13-2}^R \neq \emptyset$ . Now, by Claim B (b), one of  $X_{12-3}^L, X_{13-2}^L$  is empty. By symmetry, we can assume  $X_{13-2}^L = \emptyset$ . Now, by Claim C,  $X_2^L \neq X_3^L$ , so  $X_{12-3}^L \neq \emptyset$ . Note that  $X_{12-3}^L \rightarrow X_{12-3}^R \rightarrow X_{1-23}^L$ , thus  $X_{12-3}^L \rightarrow X_{1-23}^L$  because  $T$  is acyclic. We also have  $X_{123}^L \rightarrow X_{12-3}^L$  as  $X_{123}^L \rightarrow X_{13-2}^R \rightarrow X_{12-3}^L$ , and  $X_{12-3}^L \rightarrow X_{23-1}^L$  as  $X_{12-3}^L \rightarrow X_{12-3}^R \rightarrow X_{23-1}^L$ . This implies that in  $L$  all arcs between  $X_{12-3}^L$  and  $X_{23-1}^L \cup X_{123}^L \cup X_{1-23}^L$  are entering  $X_{12-3}^L$  (the arcs between  $X_{123}^L$  and  $X_{12-3}^L$  were reversed twice and those between  $X_{1-23}^L \cup X_{23-1}^L$  and  $X_{12-3}^L$  were reversed once). Hence, as  $L$  is strong, we must have an arc  $uz$  from  $X_{12-3}^L$  to  $Z^L$ . But  $Z^L \rightarrow X_{13-2}^R \rightarrow X_{12-3}^L$  so together with  $uz$  we have a directed 3-cycle in  $T$ , contradiction. Hence  $X_{23-1}^R \neq \emptyset$ .

Observe that  $X_{12-3}^R \cup X_{13-2}^R \rightarrow X_{23-1}^R$  as  $X_{12-3}^R \cup X_{13-2}^R \rightarrow X_{1-23}^L \rightarrow X_{23-1}^R$ .

If  $X_{12-3}^L \neq \emptyset$ , then  $X_{23-1}^R \rightarrow X_{12-3}^L \rightarrow X_{12-3}^R \rightarrow X_{23-1}^R$ , a contradiction. So  $X_{12-3}^L = \emptyset$ . But  $X_2^L \neq X_3^L$  by Claim C. Thus  $X_{13-2}^L \neq \emptyset$ . As  $X_{23-1}^R \rightarrow X_{13-2}^L \rightarrow X_{123}^R$ , we have  $X_{23-1}^R \rightarrow X_{123}^R$ . This implies that in  $R$  all the arcs between  $X_{23-1}^R$  and  $X_{13-2}^R \cup X_{123}^R \cup X_{12-3}^R$  are leaving  $X_{23-1}^R$ . So

as  $R$  is strong there must be an arc in  $R$  from  $Z^R$  to  $X_{23-1}^R$ . This arc is not reversed, so it is also an arc in  $T$ . But since  $X_{23-1}^R \rightarrow X_{13-2}^L \rightarrow Z^R$ , this arc is in a directed 3-cycle, a contradiction. This completes Case 2.

**Case 3:** Exactly one of  $X_{1-23}^L, X_{2-13}^L, X_{3-12}^L$  is non-empty and exactly one of  $X_{1-23}^R, X_{2-13}^R, X_{3-12}^R$  is non-empty.

By symmetry we can assume  $X_{1-23}^L \neq \emptyset$ .

**Subcase 3.1:**  $X_{1-23}^R \neq \emptyset$ .

By Claim C,  $X_2^L \neq X_3^L$ , so one of  $X_{12-3}^L$  and  $X_{13-2}^L$  is non-empty. By symmetry we may assume  $X_{12-3}^L \neq \emptyset$ .

Suppose  $X_{12-3}^R \neq \emptyset$ . Then  $X_{23-1}^R = \emptyset$  as  $X_{1-23}^L \rightarrow X_{23-1}^R \rightarrow X_{12-3}^L \rightarrow X_{12-3}^R \rightarrow X_{1-23}^L$ , and  $X_{23-1}^L = \emptyset$  as  $X_{1-23}^R \rightarrow X_{12-3}^L \rightarrow X_{12-3}^R \rightarrow X_{23-1}^L \rightarrow X_{1-23}^R$ .

By Claim B (b), one of  $X_{13-2}^L, X_{13-2}^R$  is empty. By symmetry, we may assume  $X_{13-2}^R = \emptyset$ .

Observe that  $V(R) \setminus Z^R = X_{123}^R \cup X_{12-3}^R \cup X_{1-23}^R$ , so  $V(R) \setminus Z^R \rightarrow X_{1-23}^L \rightarrow Z^R$ , so  $V(R) \setminus Z^R \rightarrow Z^R$ . But all the arcs incident to  $Z^R$  are not inversed, so in  $R$ , there is no arc from  $Z^R$  to  $V(R) \setminus Z^R$ . Since  $R$  is strong,  $Z^R = \emptyset$ .

Now  $X_{1-23}^R \rightarrow X_{12-3}^R \cup X_{123}^R$  because  $X_{1-23}^R \rightarrow X_{12-3}^L \rightarrow X_{12-3}^R \cup X_{123}^R$ . But all the arcs between  $X_{1-23}^R$  and  $X_{12-3}^R \cup X_{123}^R = V(R) \setminus X_{1-23}^R$  are inversed from  $R$  to  $T$ . Hence in  $R$ , no arcs leaves  $X_{1-23}^R$  in  $R$ , a contradiction to  $R$  being strong.

Hence  $X_{12-3}^R = \emptyset$ . As  $X_2^R \neq X_3^R$  this implies  $X_{13-2}^R \neq \emptyset$ .

Suppose that  $X_{23-1}^R = \emptyset$ , then  $X_{123}^R \neq \emptyset$  because  $X_2^R \neq \emptyset$  by Claim A. Furthermore  $X_{13-2}^R \rightarrow X_{123}^R$  as  $X_{13-2}^R \rightarrow X_{12-3}^L \rightarrow X_{123}^R$ , and  $X_{12-3}^L \rightarrow X_{1-23}^R$  as  $X_{12-3}^L \rightarrow X_{123}^R \rightarrow X_{1-23}^R$ . This implies that  $X_{123}^L = \emptyset$  as  $X_{123}^L \rightarrow X_{13-2}^R \rightarrow X_{123}^R \rightarrow X_{123}^L$ .

Since  $L$  is strong, there must be an arc  $uv$  leaving  $X_{12-3}^L$  in  $L$ . But  $v$  cannot be in  $X_{1-23}^L$  since all vertices of this set dominate  $X_{12-3}^L$  in  $L$ . Moreover  $v$  cannot be in  $Z^L$  for otherwise  $(u, v, w, u)$  would be a directed 3-cycle in  $T$  for any  $w \in X_{1-23}^R$  since  $Z^L \rightarrow X_{1-23}^R \rightarrow X_{12-3}^L$ .

Hence  $v \in X_{13-2}^L \cup X_{23-1}^L$ , so  $X_{13-2}^L \cup X_{23-1}^L \neq \emptyset$ . As  $X_{13-2}^L \rightarrow X_{13-2}^R \rightarrow X_{23-1}^L \rightarrow X_{1-23}^R \rightarrow X_{13-2}^L$ , precisely one of  $X_{13-2}^L, X_{23-1}^L$  is non-empty.

If  $X_{13-2}^L \neq \emptyset$  and  $X_{23-1}^L = \emptyset$ , then  $X_{13-2}^L \rightarrow X_{13-2}^R \rightarrow X_{1-23}^L \cup X_{12-3}^L$  implies that  $X_{13-2}^L \rightarrow X_{1-23}^L \cup X_{12-3}^L$ . As  $d_L^+(X_{13-2}^L) > 0$  there exists  $z \in Z^L$  such that there is an arc  $uz$  from  $X_{13-2}^L$  to  $Z^L$ , but then  $z \rightarrow X_{1-23}^R \rightarrow u \rightarrow z$  is a contradiction. Hence  $X_{13-2}^L = \emptyset$  and  $X_{23-1}^L \neq \emptyset$ . Then  $X_{23-1}^L \rightarrow X_1^L$  as  $X_{23-1}^L \rightarrow X_{1-23}^R \rightarrow X_1^L$ .

Note that  $Z^L = \emptyset$  as every vertex in  $V(L) \setminus Z^L$  has an in-neighbour in  $V(R)$  in  $T$ , implying that there can be no arc from  $V(L) \setminus Z^L$  to  $Z^L$  in  $L$ . Thus  $V(L) = X_{1-23}^L \cup X_{12-3}^L \cup X_{23-1}^L$  where each of these sets induces an acyclic subtournament of  $L$  and we have  $X_{1-23}^L \Rightarrow X_{12-3}^L \Rightarrow X_{23-1}^L \Rightarrow X_{1-23}^L$  in  $L$ . But now inverting the set  $X_{1-23}^L \cup X_{23-1}^L$  makes  $L$  acyclic, a contradiction to  $\text{inv}(L) \geq 2$ . Thus  $X_{23-1}^R \neq \emptyset$ .

Suppose  $X_{23-1}^L = \emptyset$ . As above  $Z^L = \emptyset$ , so  $V(L) = X_1^L$ . As  $X_{1-23}^L \rightarrow X_{23-1}^R \rightarrow X_{12-3}^L \cup X_{13-2}^L$  we have  $X_{1-23}^L \rightarrow X_{12-3}^L \cup X_{13-2}^L$ . Thus, using  $d_L^+(X_{1-23}^L) > 0$ , we get  $X_{123}^L \neq \emptyset$ . As  $X_{123}^R \rightarrow X_{123}^L \rightarrow X_{23-1}^R \rightarrow X_{12-3}^L \rightarrow X_{123}^R$ , we have  $X_{123}^R = \emptyset$ . Moreover  $X_1^R \rightarrow X_{23-1}^R$  because  $X_1^R \rightarrow X_{1-23}^L \rightarrow X_{23-1}^R$ . We also have  $X_{1-23}^R \rightarrow X_{13-2}^R$  as  $X_{1-23}^R \rightarrow X_{123}^L \rightarrow X_{13-2}^R$ . Now  $V(R) \setminus Z^R = X_{1-23}^R \cup X_{13-2}^R \cup X_{23-1}^R \rightarrow X_{12-3}^L \rightarrow Z^R$ . Thus  $Z^R = \emptyset$  and  $V(R) = X_{1-23}^R \cup X_{13-2}^R \cup X_{23-1}^R$  where each of these sets induces an acyclic subtournament in  $R$  and  $X_{1-23}^R \Rightarrow X_{23-1}^R \Rightarrow X_{13-2}^R \Rightarrow X_{1-23}^R$  in  $D$ . But then inverting  $X_{1-23}^R \cup X_{23-1}^R$  we make  $R$  acyclic, a contradiction to  $\text{inv}(R) \geq 2$ . Thus  $X_{23-1}^L \neq \emptyset$ .

Therefore  $X_{13-2}^L = \emptyset$  as  $X_{13-2}^L \rightarrow X_{13-2}^R \rightarrow X_{23-1}^L \rightarrow X_{23-1}^R \rightarrow X_{13-2}^L$ . As  $X_{1-23}^L \rightarrow X_{23-1}^R \rightarrow X_{12-3}^L$  we have  $X_{1-23}^L \rightarrow X_{12-3}^L$ ; as  $X_{23-1}^L \rightarrow X_{1-23}^R \rightarrow X_{1-23}^L \cup X_{12-3}^L$  we have  $X_{23-1}^L \rightarrow X_{1-23}^L \cup X_{12-3}^L$ ; As  $X_{1-23}^R \rightarrow X_{1-23}^L \rightarrow X_{23-1}^R$  we have  $X_{1-23}^R \rightarrow X_{23-1}^R$ ; as  $X_{13-2}^R \rightarrow X_{23-1}^L \rightarrow X_{1-23}^R \cup X_{23-1}^R$  we have  $X_{13-2}^R \rightarrow X_{1-23}^R \cup X_{23-1}^R$ .

Because  $X_{13-2}^R \cup X_{23-1}^R \cup X_{1-23}^R \rightarrow X_{12-3}^L$  and  $X_{123}^R \rightarrow X_{1-23}^L$ , every vertex in  $V(R) \setminus Z^R$  has an out-neighbour in  $V(L)$ . As above, we derive  $Z^R = \emptyset$ . Similarly, because  $X_{13-2}^R \rightarrow X_{12-3}^L \cup X_{23-1}^L$ ,  $X_{1-23}^R \rightarrow X_{123}^L$ , and  $X_{123}^R \rightarrow X_{1-23}^L$ , every vertex in  $V(L) \setminus Z^L$  has in-neighbour in  $V(R)$ , and so  $Z^L = \emptyset$ . Next observe that at least one of the sets  $X_{123}^R, X_{123}^L$  must be empty as  $X_{123}^R \rightarrow X_{123}^L \rightarrow X_{23-1}^R \rightarrow X_{12-3}^L \rightarrow X_{123}^R$ . If  $X_{123}^R = \emptyset$  then  $V(R) = X_{1-23}^R \cup X_{13-2}^R \cup X_{23-1}^R$  where each of these sets induces an acyclic subtournament of  $R$  and  $X_{1-23}^R \Rightarrow X_{23-1}^R \Rightarrow X_{13-2}^R$  and  $X_{1-23}^R \Rightarrow X_{13-2}^R$ . Thus  $R$  is acyclic, contradicting  $\text{inv}(R) \geq 2$ . So  $X_{123}^R \neq \emptyset$  and  $X_{123}^L = \emptyset$ . As

above we obtain a contradiction by observing that  $L$  is acyclic, contradicting  $\text{inv}(L) \geq 2$ . This completes the proof of Subcase 3.1.

**Subcase 3.2**  $X_{1-23}^R = \emptyset$ .

By symmetry, we can assume  $X_{2-13}^R = \emptyset$  and  $X_{3-12}^R \neq \emptyset$ . Hence  $X_{1-23}^L \rightarrow X_3^L$  because  $X_{1-23}^L \rightarrow X_{3-12}^R \rightarrow X_3^L$ , and  $X_1^R \rightarrow X_{3-12}^R$  because  $X_1^R \rightarrow X_{1-23}^L \rightarrow X_{3-12}^R$ . Note that one of  $X_{13-2}^L, X_{13-2}^R$  is empty since  $X_{13-2}^L \rightarrow X_{13-2}^R \rightarrow X_{1-23}^L \rightarrow X_{3-12}^R \rightarrow X_{13-2}^L$ . By symmetry we can assume that  $X_{13-2}^L = \emptyset$ . By Claim C,  $X_2^L \neq X_3^L$ , so  $X_{12-3}^L \neq \emptyset$ .

Suppose first that  $X_{123}^R \neq \emptyset$ . Then  $X_{23-1}^L = \emptyset$  since  $X_{23-1}^L \rightarrow X_{123}^R \rightarrow X_{1-23}^L \rightarrow X_{23-1}^L$ . Now, by Claim A,  $X_3^L \neq \emptyset$  so  $X_{123}^L \neq \emptyset$ . Now  $X_{123}^L \rightarrow X_{13-2}^R \rightarrow X_{1-23}^L \rightarrow X_{123}^L$ , so  $X_{13-2}^R = \emptyset$ . Furthermore,  $X_{23-1}^R \rightarrow X_{12-3}^L \rightarrow X_{123}^R \rightarrow X_{1-23}^L \rightarrow X_{23-1}^R$  so  $X_{23-1}^R = \emptyset$ . Therefore  $X_1^R = X_2^R$ , a contradiction to Claim C. Thus  $X_{123}^R = \emptyset$ .

Next suppose  $X_{123}^L \neq \emptyset$ . Then  $X_{12-3}^R = \emptyset$  because  $X_{12-3}^R \rightarrow X_{3-12}^R \rightarrow X_{123}^L \rightarrow X_{12-3}^R$ . By Claim A,  $X_1^R, X_2^R \neq \emptyset$ , so  $X_{13-2}^R \neq \emptyset$  and  $X_{23-1}^R \neq \emptyset$ . As  $X_{13-2}^R \rightarrow X_{1-23}^L \rightarrow X_{3-12}^R \cup X_{23-1}^R$  we have  $X_{13-2}^R \rightarrow X_{3-12}^R \cup X_{23-1}^R$ . Since  $d_R^+(X_{13-2}^R) > 0$  we have  $Z^R \neq \emptyset$ . However, there can be no arcs from  $Z^R$  to  $X_3^R = V(R) \setminus Z^R$ , because  $X_3^R \rightarrow X_{123}^L \rightarrow Z^R$ . This contradicts the fact that  $R$  is strong. Thus  $X_{123}^L = \emptyset$ .

By Claim A,  $X_3^L \neq \emptyset$ , so  $X_{23-1}^L \neq \emptyset$ . Thus  $X_{23-1}^R = \emptyset$  because  $X_{23-1}^R \rightarrow X_{12-3}^L \rightarrow X_{3-12}^R \rightarrow X_{23-1}^R \rightarrow X_{23-1}^R$ . By Claim A,  $X_2^R \neq \emptyset$  so  $X_{12-3}^R \neq \emptyset$ . By Claim C,  $X_1^R \neq X_2^R$ , so  $X_{13-2}^R \neq \emptyset$ . As  $X_{12-3}^L \rightarrow X_{12-3}^R \rightarrow X_{1-23}^L \cup X_{23-1}^L$ , we have  $X_{12-3}^L \rightarrow X_{1-23}^L \cup X_{23-1}^L$ . Thus the fact that  $d_L^+(X_{12-3}^L) > 0$  implies that there is an arc  $vz$  from  $X_{12-3}^L$  to  $Z^L$ . But then for any  $u \in X_{13-2}^R$ ,  $(u, v, z, u)$  is directed 3-cycle, a contradiction.

This completes Subcase 3.2.

**Case 4:** All three of  $X_{1-23}^L, X_{2-13}^L, X_{3-12}^L$  or all three of  $X_{1-23}^R, X_{2-13}^R, X_{3-12}^R$  are non-empty.

By symmetry, we can assume that  $X_{1-23}^L, X_{2-13}^L, X_{3-12}^L \neq \emptyset$ . There do not exist  $i \neq j \in [3]$  such that  $X_i^R \setminus X_j^R, X_j^R \setminus X_i^R \neq \emptyset$ , for otherwise  $X_{i-jk}^L \rightarrow (X_j^R \setminus X_i^R) \rightarrow X_{j-ik}^L \rightarrow (X_i^R \setminus X_j^R) \rightarrow$

$X_{i-jk}^L$ , a contradiction. Hence we may assume by symmetry that  $X_2^R \setminus X_1^R, X_3^R \setminus X_1^R, X_2^R \setminus X_3^R = \emptyset$ . This implies that  $X_2^R = X_{123}^R$ ,  $X_3^R = X_{123}^R \cup X_{13-2}^R$  and  $X_1^R = X_{123}^R \cup X_{13-2}^R \cup X_{1-23}^R$ . Moreover,  $X_{1-23}^R, X_{123}^R, X_{13-2}^R \neq \emptyset$  by Claim C. As  $X_3^R \rightarrow X_{3-12}^L \rightarrow X_{1-23}^R$  we have  $X_3^R \rightarrow X_{1-23}^R$ , so since  $d_R^-(X_{1-23}^R) > 0$  we must have an arc from  $Z^R$  to  $X_{1-23}^R$  and now  $X_{1-23}^R \rightarrow X_{1-23}^L \rightarrow Z^R$  gives a contradiction. This completes Case 4.

**Case 5:** Exactly two of  $X_{1-23}^L, X_{2-13}^L, X_{3-12}^L$  or two of  $X_{1-23}^R, X_{2-13}^R, X_{3-12}^R$  are non-empty.

By symmetry we can assume that  $X_{1-23}^L, X_{2-13}^L \neq \emptyset$  and  $X_{3-12}^L = \emptyset$ .

**Subcase 5.1:**  $X_{1-23}^R, X_{2-13}^R, X_{3-12}^R = \emptyset$ .

As  $X_{1-23}^L \rightarrow X_{23-1}^R \rightarrow X_{2-13}^L \rightarrow X_{13-2}^R \rightarrow X_{1-23}^L$ , one of  $X_{13-2}^R, X_{23-1}^R$  is empty. By symmetry we may assume that  $X_{23-1}^R = \emptyset$ . By Claim C,  $X_1^R \neq X_2^R$  and  $X_1^R \neq X_3^R$ , so  $X_{13-2}^R \neq \emptyset$  and  $X_{12-3}^R \neq \emptyset$ . Now  $V(R) \setminus Z^R = X_1^R \rightarrow X_{1-23}^L \rightarrow Z^R$ , thus there is no arc leaving  $Z^R$ . As  $R$  is strong, we get  $Z^R = \emptyset$ .

As  $X_{12-3}^R \rightarrow X_{2-13}^L \rightarrow X_{13-2}^R$ , we have  $X_{12-3}^R \rightarrow X_{13-2}^R$ . Hence as  $R$  is strong, necessarily  $X_{123}^R \neq \emptyset$ . If  $X_{123}^L \neq \emptyset$ , then  $X_{123}^R \rightarrow X_{12-3}^R \cup X_{13-2}^R$  as  $X_{123}^R \rightarrow X_{123}^L \rightarrow X_{12-3}^R \cup X_{13-2}^R$ . This contradicts the fact that  $R$  is strong since  $d_R^+(X_{123}^R) = 0$ . Hence  $X_{123}^L = \emptyset$ . By Claim A,  $X_3^L \neq \emptyset$ , so  $X_{13-2}^L \cup X_{23-1}^L \neq \emptyset$ .

Since  $X_{123}^R \rightarrow X_{2-13}^L \rightarrow X_{13-2}^R$ , we have  $X_{123}^R \rightarrow X_{13-2}^R$ . We also have  $X_{12-3}^R \rightarrow X_{123}^R$  because  $X_{12-3}^R \rightarrow X_{13-2}^L \cup X_{23-1}^L \rightarrow X_{123}^R$ . Hence  $V(R) = X_{12-3}^R \cup X_{13-2}^R \cup X_{123}^R$  where each of these sets induces an acyclic subtournament of  $R$  and  $X_{13-2}^R \Rightarrow X_{12-3}^R \Rightarrow X_{123}^R \Rightarrow X_{13-2}^R$ . Thus inverting  $X_{12-3}^R \cup X_{13-2}^R$  makes  $R$  acyclic, contradicting  $\text{inv}(R) \geq 2$ .

This completes Subcase 5.1

**Subcase 5.2:**  $X_{1-23}^R \neq \emptyset$  and  $X_{2-13}^R \cup X_{3-12}^R = \emptyset$ .

We first observe that since  $X_{2-13}^L \cup X_{23-1}^L \rightarrow X_{1-23}^R \rightarrow X_1^L$  we can conclude that  $X_{2-13}^L \rightarrow X_1^L$  and  $X_{23-1}^L \rightarrow X_1^L$ . As  $X_{23-1}^R \rightarrow X_{2-13}^L \rightarrow X_{1-23}^R \rightarrow X_{23-1}^R$ , we have  $X_{23-1}^R = \emptyset$ . Now  $V(R) \setminus Z^R = X_1^R$  and  $X_1^R \rightarrow X_{1-23}^L \rightarrow Z^R$ . So  $V(R) \setminus Z^R \rightarrow Z^R$ . Since  $R$  is strong,  $Z^R = \emptyset$ . Now Claims A and C imply that at least two of the sets  $X_{13-2}^R, X_{123}^R, X_{12-3}^R$  are non-empty. This implies that every vertex of  $V(L)$  has an in-neighbour in  $V(R)$  (as  $X_{1-23}^R \rightarrow X_1^L, X_{13-2}^R \cup X_{12-3}^R \rightarrow X_{23-1}^L$

and  $X_2^R \rightarrow X_{2-13}^L$ ) so we must have  $Z^L = \emptyset$ .

Suppose first that  $X_{12-3}^R = \emptyset$ . By Claim A,  $X_2^R \neq \emptyset$ , so  $X_{123}^R \neq \emptyset$ . Moreover, by Claim C,  $X_2^R \neq X_3^R$ , so  $X_{13-2}^R \neq \emptyset$ . Since  $X_{12-3}^L \cup X_{13-2}^L \rightarrow X_{123}^R \rightarrow X_{2-13}^L \rightarrow X_{12-3}^L \cup X_{13-2}^L$  we have  $X_{12-3}^L \cup X_{13-2}^L = \emptyset$ . If  $X_{23-1}^L \neq \emptyset$ , then  $X_{123}^L = \emptyset$  as  $X_{23-1}^L \rightarrow X_{123}^L \rightarrow X_{13-2}^R \rightarrow X_{23-1}^L$  and we have  $X_{2-13}^L \rightarrow X_{23-1}^L$  as  $X_{2-13}^L \rightarrow X_{13-2}^R \rightarrow X_{23-1}^L$ . Now we see that  $d_L^-(X_{23-1}^L) = 0$ , a contradiction. Hence  $X_{23-1}^L = \emptyset$  and  $X_{123}^L \neq \emptyset$  because  $X_3^L \neq \emptyset$  by Claim A. Moreover  $X_{123}^L \rightarrow X_{1-23}^L$  because  $X_{123}^L \rightarrow X_{13-2}^R \rightarrow X_{1-23}^L$ . Now  $V(L) = X_{1-23}^L \cup X_{2-13}^L \cup X_{123}^L$  where each of these sets induces an acyclic subtournament in  $L$  and  $X_{1-23}^L \Rightarrow X_{123}^L \Rightarrow X_{2-13}^L \Rightarrow X_{1-23}^L$ . Then inverting the set  $X_{1-23}^L \cup X_{2-13}^L$  makes  $L$  acyclic, a contradiction to  $\text{inv}(L) \geq 2$ . Thus  $X_{12-3}^R \neq \emptyset$ .

Note that  $X_{12-3}^R \rightarrow X_{1-23}^R \cup X_{13-2}^R$  as  $X_{12-3}^R \rightarrow X_{2-13}^L \rightarrow X_{1-23}^R \cup X_{13-2}^R$ . Thus  $X_{123}^L = \emptyset$  because  $X_{123}^L \rightarrow X_{12-3}^R \rightarrow X_{1-23}^R \rightarrow X_{123}^L$ . Furthermore the fact that  $d_R^+(X_{12-3}^R) > 0$  implies that  $X_{123}^R \neq \emptyset$  and that there is at least one arc from  $X_{12-3}^R$  to  $X_{123}^R$  in  $T$  (and in  $R$ ). We saw before that  $X_{12-3}^R \rightarrow X_{1-23}^R$  and by the same reasoning  $X_{123}^R \rightarrow X_{1-23}^R$ , hence, as  $Z^R = \emptyset$  and  $d_R^-(X_{1-23}^R) > 0$ , there is at least one arc from  $X_{1-23}^R$  to  $X_{13-2}^R$ . Hence  $X_{13-2}^R \neq \emptyset$  and  $X_{23-1}^L = \emptyset$  as  $X_{13-2}^R \rightarrow X_{23-1}^L \rightarrow X_{1-23}^R$ . We have  $X_{12-3}^L = \emptyset$  since  $X_{12-3}^L \rightarrow X_{123}^R \rightarrow X_{2-13}^L \rightarrow X_{1-23}^R \rightarrow X_{12-3}^L$ . Finally, as  $X_{2-13}^L \rightarrow X_{1-23}^R \rightarrow X_1^L$  we have  $X_{2-13}^L \rightarrow X_1^L$ . But now  $d_L^+(X_1^L) = 0$  (recall that  $Z^L = \emptyset$ ), a contradiction. This completes Subcase 5.2

**Subcase 5.3:**  $X_{3-12}^R \neq \emptyset$  and  $X_{1-23}^R \cup X_{2-13}^R = \emptyset$ .

As  $X_{23-1}^R \rightarrow X_{2-13}^L \rightarrow X_{13-2}^R \rightarrow X_{1-23}^L \rightarrow X_{23-1}^R$  one of the sets  $X_{13-2}^R, X_{23-1}^R$  must be empty. By symmetry we may assume that  $X_{23-1}^R = \emptyset$ .

Suppose first that  $X_{12-3}^R = \emptyset$ . Then, by Claim A,  $X_2^R \neq \emptyset$ , so  $X_{123}^R \neq \emptyset$ , and by Claim C,  $X_1^R \neq X_2^R$ , so  $X_{13-2}^R \neq \emptyset$ . Now  $X_{123}^L = \emptyset$  because  $X_{123}^L \rightarrow X_{13-2}^R \rightarrow X_{1-23}^L \rightarrow X_{3-12}^R \rightarrow X_{123}^L$ . As  $X_{123}^R \rightarrow X_{2-13}^L \rightarrow X_{13-2}^R \cup X_{3-12}^R$ , we have  $X_{123}^R \rightarrow X_{13-2}^R \cup X_{3-12}^R$ . Next we observe that  $X_{13-2}^L = \emptyset$  since  $X_{13-2}^L \rightarrow X_{123}^R \rightarrow X_{3-12}^R \rightarrow X_{13-2}^L$ . Now, as  $X_3^L \neq \emptyset$  by Claim C, we have  $X_{23-1}^L \neq \emptyset$  but that contradicts that  $X_{23-1}^L \rightarrow X_{123}^R \rightarrow X_{3-12}^R \rightarrow X_{23-1}^L$ . So we must have  $X_{12-3}^R \neq \emptyset$ .

First observe that  $X_{123}^L = \emptyset$  as  $X_{123}^L \rightarrow X_{12-3}^R \rightarrow X_{1-23}^L \rightarrow X_{3-12}^R \rightarrow X_{123}^L$ . As  $X_1^R \neq X_2^R$  by Claim C, we have  $X_{13-2}^R \neq \emptyset$ . Now  $X_{13-2}^L = \emptyset$  as  $X_{13-2}^L \rightarrow X_{13-2}^R \rightarrow X_{1-23}^L \rightarrow X_{3-12}^R \rightarrow X_{13-2}^L$ .

As  $X_3^L \neq \emptyset$  by Claim A, we have  $X_{23-1}^L \neq \emptyset$ . Since  $X_{12-3}^L \rightarrow X_{12-3}^R \rightarrow X_{2-13}^L \rightarrow X_{13-2}^R \rightarrow X_{12-3}^L$  we have  $X_{12-3}^L = \emptyset$ . As  $X_{1-23}^L \rightarrow X_{3-12}^R \rightarrow X_{23-1}^L$ , we have  $X_{1-23}^L \rightarrow X_{23-1}^L$ . Moreover  $X_{2-13}^L \rightarrow X_{13-2}^R \rightarrow X_{23-1}^L \cup X_{1-23}^L$  implies  $X_{2-13}^L \rightarrow X_{23-1}^L \cup X_{1-23}^L$ . We also have  $Z^L = \emptyset$  since every vertex in  $X_{1-23}^L \cup X_{23-1}^L \cup X_{2-13}^L$  has an in-neighbour in  $R$ , implying that there can be no arc entering  $Z^L$ . Now  $V(L) = X_{1-23}^L \cup X_{23-1}^L \cup X_{2-13}^L$  where each of these sets induces a transitive subtournament in  $L$  and  $X_{1-23}^L \Rightarrow X_{23-1}^L \Rightarrow X_{2-13}^L \Rightarrow X_{1-23}^L$ . However this implies that inverting  $X_{1-23}^L \cup X_{2-13}^L$  makes  $L$  acyclic, a contradiction to  $\text{inv}(L) \geq 2$ . This completes the proof of Subcase 5.3.

**Subcase 5.4:**  $X_{1-23}^R, X_{2-13}^R \neq \emptyset$  and  $X_{3-12}^R = \emptyset$ .

This case is trivial as  $X_{1-23}^L \rightarrow X_{2-13}^R \rightarrow X_{2-13}^L \rightarrow X_{1-23}^R \rightarrow X_{1-23}^L$  contradicts that  $T$  is acyclic.

By symmetry the only remaining case to consider is the following.

**Subcase 5.5:**  $X_{1-23}^R, X_{3-12}^R \neq \emptyset$  and  $X_{2-13}^R = \emptyset$ .

As  $X_{23-1}^L \rightarrow X_{1-23}^R \rightarrow X_{1-23}^L \rightarrow X_{3-12}^R \rightarrow X_{23-1}^L$  we have  $X_{23-1}^L = \emptyset$  and as  $X_{23-1}^R \rightarrow X_{2-13}^L \rightarrow X_{1-23}^R \rightarrow X_{1-23}^L \rightarrow X_{23-1}^R$  we have  $X_{23-1}^R = \emptyset$ . Note that every vertex in  $V(L)$  has an in-neighbour in  $V(R)$  (as  $X_{1-23}^R \rightarrow X_1^L$  and  $X_2^R \rightarrow X_{2-13}^L$ ) and every vertex in  $V(R)$  has an out-neighbour in  $V(L)$  (as  $X_1^R \rightarrow X_{1-23}^L$  and  $X_{3-12}^R \rightarrow X_3^L$ ). This implies that  $Z^L = \emptyset$  and  $Z^R = \emptyset$ . At least one of  $X_{13-2}^L, X_{13-2}^R$  is empty as  $X_{13-2}^L \rightarrow X_{13-2}^R \rightarrow X_{1-23}^L \rightarrow X_{3-12}^R \rightarrow X_{13-2}^L$  and at least one of  $X_{12-3}^L, X_{12-3}^R$  is empty as  $X_{12-3}^L \rightarrow X_{12-3}^R \rightarrow X_{2-13}^L \rightarrow X_{1-23}^R \rightarrow X_{12-3}^L$ .

Suppose first that  $X_{12-3}^R = \emptyset = X_{13-2}^R$ . Then  $X_2^R \neq \emptyset$  by Claim A, so  $X_{123}^R \neq \emptyset$ .

Moreover  $X_{123}^R \rightarrow X_{1-23}^R \cup X_{3-12}^R$  because  $X_{123}^R \rightarrow X_{2-13}^L \rightarrow X_{1-23}^R \cup X_{3-12}^R$ . This implies that  $d_R^+(X_{123}^R) = 0$ , a contradiction.

Suppose next that  $X_{12-3}^L = \emptyset = X_{13-2}^L$ . Then  $X_3^L \neq \emptyset$  by Claim A, so  $X_{123}^L \neq \emptyset$ . Moreover  $X_{1-23}^L \cup X_{2-13}^L \rightarrow X_{123}^L$  as  $X_{1-23}^L \cup X_{2-13}^L \rightarrow X_{3-12}^R \rightarrow X_{123}^L$ . This implies that  $d_L^-(X_{123}^L) = 0$ , a contradiction.



Now assume that  $X_{12-3}^R = \emptyset = X_{13-2}^L$  and  $X_{13-2}^R \neq \emptyset \neq X_{12-3}^L$ . Then  $X_{123}^L \neq \emptyset$  as  $X_3^L \neq \emptyset$  by Claim A and now we get the contradiction  $X_{123}^L \rightarrow X_{13-2}^R \rightarrow X_{1-23}^L \rightarrow X_{3-12}^R \rightarrow X_{123}^L$ .

The final case is  $X_{12-3}^R \neq \emptyset \neq X_{13-2}^L$  and  $X_{13-2}^R = \emptyset = X_{12-3}^L$ . We first observe that  $X_{123}^R = \emptyset$  as  $X_{123}^R \rightarrow X_{1-23}^L \rightarrow X_{3-12}^R \rightarrow X_{13-2}^L \rightarrow X_{123}^R$ . As  $X_{12-3}^R \rightarrow X_{2-13}^L \rightarrow X_{1-23}^R$  we have  $X_{12-3}^R \rightarrow X_{1-23}^R$  and as  $X_{1-23}^R \rightarrow X_{1-23}^L \rightarrow X_{3-12}^R$  we have  $X_{1-23}^R \rightarrow X_{3-12}^R$ . This implies that  $d_R^-(X_{1-23}^R) = 0$ , a contradiction. This completes the proof of Subcase 5.5 and the proof of the theorem. □

**Corollary 3.6.7.** *Let  $L$  and  $R$  be strong oriented graphs such that  $\text{inv}(L), \text{inv}(R) = 2$ . Then  $\text{inv}(L \rightarrow R) = 4$ .*

### 3.7 Inversion number of augmentations of oriented graphs

Recall that  $Q_n$  is the tournament obtained from  $TT_n$  by reversing the arcs of its directed hamiltonian path  $(v_1 v_2, \dots, v_n)$  (See Figure 10). Belkhechine et al. (BELKHECHINE *et al.*, 2010) conjectured the following about the inversion number of  $Q_n$ .

**Conjecture 3.2.9** ((BELKHECHINE *et al.*,)). *For every  $n \geq 3$ ,  $\text{inv}(Q_n) = \lfloor \frac{n-1}{2} \rfloor$ .*

A possible way to prove Conjecture 3.2.9 would be via augmentations. Let  $D$  be an oriented graph and  $z$  a vertex of  $D$ . The  $z$ -**augmentation** of  $D$  is the digraph, denoted by  $\sigma(z, D)$ , obtained from  $D$  by adding two new vertices  $y$  and  $x$ , the arc  $zy, yx$  and  $xz$  and all the arcs from  $\{x, y\}$  to  $V(D) \setminus \{z\}$ . We let  $\sigma_i(z, D)$  be the  $z$ -augmentation of  $D$  on which the vertices added are denoted by  $x_i$  and  $y_i$ .

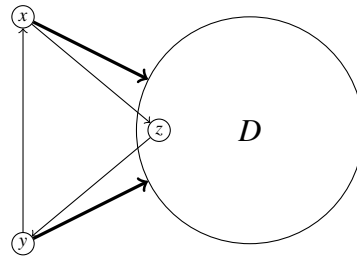

Figure 16 – The  $z$ -augmentation  $\sigma(z, D)$  of a digraph  $D$  (Source: (BANG-JENSEN *et al.*, 2022)).

Observe that  $Q_n = \sigma(v_1, Q_{n-2})$ . In this section, we prove that if  $D$  is an oriented graph with  $\text{inv}(D) = 1$  Then  $\text{inv}(\sigma(z, D)) = 2$  for every  $z \in V(D)$  (Proposition 3.7.1). In particular, this implies that  $\text{inv}(Q_5) = 2$ .

Unfortunately, for larger values of  $\text{inv}(D)$ , it is not true that  $\text{inv}(\sigma(z, D)) = \text{inv}(D) + 1$  for every  $z \in V(D)$ . For example, take the directed 3-cycle  $\vec{C}_3$  with vertex set  $\{a, b, c\}$  and consider  $H_1 = \sigma_1(a, \vec{C}_3)$ , and  $H_2 = \sigma_2(a, H_1)$ . See Figure 17. By Proposition 3.7.1, we have  $\text{inv}(H_1) = 2$  but  $\text{inv}(H_2) = 2$  as  $(\{y_1, y_2, b\}, \{y_1, y_2, a, b\})$  is a decycling family of  $H_2$ .

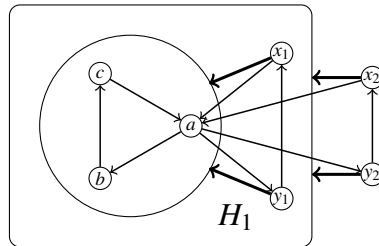

Figure 17 – The digraph  $H_2$  (Source: (BANG-JENSEN *et al.*, 2022)).

However, we prove in Theorem 3.7.2 that if  $\text{inv}(D) = 1$ , then  $\text{inv}(\sigma_1(x_2, \sigma_2(z, D))) = 3$  for every  $z \in V(D)$ . This directly implies  $\text{inv}(Q_7) = 3$ .

**Lemma 3.7.1.** *Let  $D$  be an oriented graph with  $\text{inv}(D) = 1$ . Then  $\text{inv}(\sigma(z, D)) = 2$  for every  $z \in V(D)$ .*

*Proof.* Recall that  $\text{inv}(\sigma(z, D)) \leq \text{inv}(D) + 1 = 2$  for every vertex  $z \in V(D)$ .

Suppose for a contradiction that there is a vertex  $z$  of  $D$  such that  $\text{inv}(\sigma(z, D)) = 1$ . Let  $X$  be a set whose inversion in  $\sigma(z, D)$  results in an acyclic digraph  $D^*$ .

As  $D$  has inversion number 1 it has a directed cycle  $C$ . The set  $X$  contains an arc  $uu^+$  of  $C$ , for otherwise  $C$  would be a directed cycle in  $D^*$ . Moreover,  $X$  does not contain all vertices of  $C$ , for otherwise the inversion of  $X$  transforms  $C$  in the directed cycle in the opposite direction. Hence, without loss of generality, we may assume that  $u^-$ , the in-neighbour of  $u$  in  $C$  is not in  $X$ .

Note also that  $C' = (z, y, x, z)$  is a directed cycle in  $\sigma(z, D)$  so  $X$  must contain exactly two vertices of  $C'$ . In particular, there is a vertex, say  $w$ , in  $\{x, y\} \cap X$ .

- If  $z \notin \{u^-, u\}$ , then  $(w, u^-, u, w)$  is a directed 3-cycle, a contradiction.
- If  $z = u$ , then either  $X \cap V(C') = \{x, z\}$  and  $(z, x, u^-, z)$  is a directed 3-cycle in  $D^*$ , or  $X \cap V(C') = \{y, z\}$  and  $(x, u^+, y, x)$  is a directed 3-cycle in  $D^*$ , a contradiction.

- If  $z = u^-$ , then  $X \cap V(C') = \{x, y\}$  and  $(z, u, x, z)$  is a directed 3-cycle in  $D^*$ , a contradiction.  $\square$

Recall that  $\sigma_i(z, D)$  denotes the  $z$ -augmentation of  $D$  on which the vertices added are denoted by  $x_i$  and  $y_i$ .

**Theorem 3.7.2.** *Let  $D$  be an oriented graph with  $\text{inv}(D) = 1$  and let  $H = \sigma_1(x_2, \sigma_2(z, D))$ . Then,  $\text{inv}(H) = 3$ .*

*Proof.* By Lemma 3.7.1,  $\text{inv}(\sigma_2(z, D)) = 2$ . In addition,  $\sigma_2(z, D)$  is a subdigraph of  $H$ , so by Proposition 3.2.1,  $\text{inv}(H) \geq 2$ . Moreover,  $\text{inv}(H) \leq \text{inv}(\sigma_2(z, D)) + 1 = 3$ .

Assume for a contradiction that  $\text{inv}(H) = 2$ . Let  $(X_1, X_2)$  be a decycling family of  $H$ . For  $i \in [2]$ , let  $H_i = \text{Inv}(H; X_i)$ . Note that  $\text{inv}(H_i) \leq 1$  for  $i \in [2]$ , because  $(X_1, X_2)$  is a decycling family.

Then  $(X_1 \setminus \{y_2\}, X_2 \setminus \{y_2\})$  is a decycling family of  $H - y_2$ . But  $H - y_2$  is isomorphic to  $\vec{C}_3 \rightarrow D$  with  $(y_1, x_1, x_2, y_1)$  dominating  $D$ . Thus, by Proposition 3.6.1,  $\text{inv}(H - y_2) \geq 2$  and furthermore, by Theorem 3.6.3, we may assume that  $X_1 \subseteq \{x_1, y_1, x_2, y_2\}$ . Observe that  $X_1 \cap |\{x_1, y_1, x_2\}| = 2$ , for otherwise  $H_1 - y_2 = H - y_2$  and  $\text{inv}(H_1) \geq \text{inv}(H_1 - y_2) \geq 2$  by Proposition 3.2.1. Hence, there is a vertex  $v \in \{y_1, x_1, x_2\}$  such that  $y_2 v \in A(H_1)$ . This implies that  $H_1 \langle \{v, y_2\} \cup V(D) \rangle$  is a  $z$ -augmentation of  $D$ . Therefore, by Lemma 3.7.1, we must have  $\text{inv}(H_1 \langle \{v, y_2\} \cup V(D) \rangle) = 2$ , and so by Proposition 3.2.1,  $\text{inv}(H_1) \geq 2$ , a contradiction.

Thus, we have shown that  $\text{inv}(H) = 3$ .  $\square$

It is easy to check that  $Q_7$  is the oriented graph  $\sigma_1(v_3, \sigma_2(v_5, \vec{C}_3))$ , where  $\vec{C}_3$  is the directed 3-cycle  $(v_5, v_7, v_6, v_5)$ ,  $x_2 = v_3$ ,  $y_2 = v_4$ ,  $x_1 = v_1$  and  $y_1 = v_2$ . Thus, Theorem 3.7.2 yields the following.

**Corollary 3.7.3.**  $\text{inv}(Q_7) = 3$ .

### 3.8 Inversion number of intercylic oriented graphs

A digraph  $D$  is **intercyclic** if  $v(D) = 1$ . The aim of this subsection is to prove the following theorem.

**Theorem 3.8.1.** *If  $D$  is an intercylic oriented graph, then  $\text{inv}(D) \leq 4$ .*

In order to prove this theorem, we need some preliminaries.

Let  $D$  be an oriented graph. An arc  $uv$  is **weak** in  $D$  if  $\min\{d^+(u), d^-(v)\} = 1$ . An arc is **contractable** in  $D$  if it is weak and in no directed 3-cycle. If  $a$  is a contractable arc, then let  $D/a$  is the digraph obtained by contracting the arc  $a$  and  $\tilde{D}/a$  be the oriented graph obtained from  $D$  by removing one arc from every pair of parallel arcs created in  $D/a$ .

**Lemma 3.8.2.** *Let  $D$  be a strongly connected oriented graph and let  $a$  be a contractable arc in  $D$ . Then  $D/a$  is a strongly connected intercylic oriented graph and  $\text{inv}(\tilde{D}/a) \geq \text{inv}(D)$ .*

*Proof.* McCuaig proved that  $D/a$  is strong and intercylic. Let us prove that  $\text{inv}(D) \leq \text{inv}(\tilde{D}/a)$ . Observe that  $\text{inv}(\tilde{D}/a) = \text{inv}(D/a)$ .

Set  $a = uv$ , and let  $w$  be the vertex corresponding to both  $u$  and  $v$  in  $D/a$ . Let  $(X'_1, \dots, X'_p)$  be a decycling family of  $D' = \tilde{D}/a$  that result in an acyclic oriented graph  $R'$ . For  $i \in [p]$ , let  $X_i = X'_i$  if  $w \notin X'_i$  and  $X_i = (X'_i \setminus \{w\}) \cup \{u, v\}$  if  $w \in X'_i$ . Let  $a^* = uv$  if  $w$  is in an even number of  $X'_i$  and  $a^* = vu$  otherwise, and let  $R = \text{Inv}(D; (X_1, \dots, X_p))$ . One easily shows that  $R = R'/a^*$ . Therefore  $R$  is acyclic since the contraction of an arc transforms a directed cycle into a directed cycle.  $\square$

**Lemma 3.8.3.** *Let  $D$  be an intercylic oriented graph. If there is a non-contractable weak arc, then  $\text{inv}(D) \leq 4$ .*

*Proof.* Let  $uv$  be a non-contractable weak arc. By directional duality, we may assume that  $d^-(v) = 1$ . Since  $uv$  is non-contractable,  $uv$  is in a directed 3-cycle  $(u, v, w, u)$ . Since  $D$  is intercylic, we have  $D \setminus \{u, v, w\}$  is acyclic. Consequently,  $\{w, u\}$  is a cycle transversal of  $D$ , because every directed cycle containing  $v$  also contains  $u$ . Hence, by Theorem 3.4.1,  $\text{inv}(D) \leq 2\tau(D) \leq 4$ .  $\square$

The description below follows (BANG-JENSEN; KRIESELL, 2011). A digraph  $D$  is **in reduced form** if it is strong, and it has no weak arc, that is  $\min\{\delta^-(D), \delta^+(D)\} \geq 2$ .

Intercyclic digraphs in reduced form were characterized by Mc Cuaig (MCCUAIG, 1991). In order to restate his result, we need some definitions. Let  $\mathcal{P}(x_1, \dots, x_s; y_1, \dots, y_t)$  be the class of acyclic digraphs  $D$  such that  $x_1, \dots, x_s$ ,  $s \geq 2$ , are the sources of  $D$ ,  $y_1, \dots, y_t$ ,  $t \geq 2$ , are the sinks of  $D$ , every vertex which is neither a source nor a sink has in- and out-degree at least 2, and, for  $1 \leq i < j \leq s$  and  $1 \leq k < \ell \leq t$ , every  $(x_i, y_\ell)$ -path intersects every  $(x_j, y_k)$ -path. By a theorem of Metzlar (METZLAR, 1989), such a digraph can be embedded in a disk such

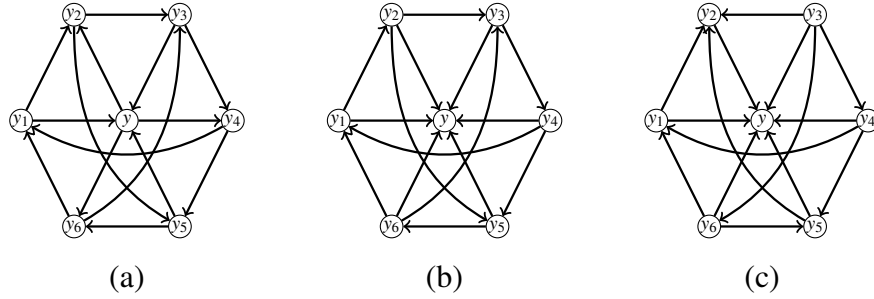

Figure 18 – (a): the digraph  $D_7$ ; (b): the digraph  $D'_7$  obtained from  $D_7$  by inverting the set  $\{y, y_2, y_4, y_6\}$ ; (c): the acyclic digraph  $D''_7$  obtained from  $D'_7$  by inverting the set  $\{y_2, y_3, y_5, y_6\}$ . (Source: (BANG-JENSEN *et al.*, 2022)).

that  $x_1, x_2, \dots, x_s, y_t, y_{t-1}, \dots, y_1$  occur, in this cyclic order, on its boundary. Let  $\mathcal{T}$  be the class of digraphs with minimum in- and out-degree at least 2 which can be obtained from a digraph in  $\mathcal{P}(x^+, y^+; x^-, y^-)$  by identifying  $x^+ = x^-$  and  $y^+ = y^-$ . Let  $D_7$  be the digraph from Figure 18(a).

Let  $\mathcal{K}$  be the class of digraphs  $D$  with  $\tau(D) \geq 3$  and  $\delta^0(D) \geq 2$  (Recall that  $\delta^0(D) = \min\{\delta^+(D), \delta^-(D)\}$ .) which can be obtained from a digraph  $K_H$  from  $\mathcal{P}(w_0, z_0; z_1, w_1)$  by adding at most one arc connecting  $w_0, z_0$ , adding at most one arc connecting  $w_1, z_1$ , adding a directed 4-cycle  $(x_0, x_1, x_2, x_3, x_0)$  disjoint from  $K_H$  and adding eight single arcs  $w_1x_0, w_1x_2, z_1x_1, z_1x_3, x_0w_0, x_2w_0, x_1z_0, x_3z_0$  (see Figure 19). Let  $\mathcal{H}$  be the class of digraphs  $D$  with  $\tau(D) \geq 3$

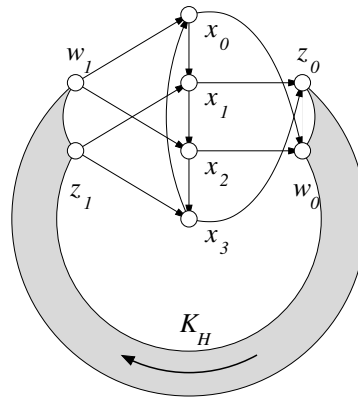

Figure 19 – The digraphs from  $\mathcal{K}$ . The arrow in the grey area symbolizing the acyclic (plane) digraph  $K_H$  indicates that  $z_0, w_0$  are its sources and  $z_1, w_1$  are its sinks. (This figure is a courtesy of (BANG-JENSEN; KRIESELL, 2011)).

and  $\delta^0(D) \geq 2$  such that  $D$  is the union of three arc-disjoint digraphs  $H_\alpha \in \mathcal{P}(y_4, y_3, y_1; y_5, y_2)$ ,  $H_\beta \in \mathcal{P}(y_4, y_5; y_3, y_1, y_2)$ , and  $H_\gamma \in \mathcal{P}(y_1, y_2; y_3, y_4)$ , where  $y_1, y_2, y_3, y_4, y_5$  are the only vertices in  $D$  occurring in more than one of  $H_\alpha, H_\beta, H_\gamma$  (see Figure 20).

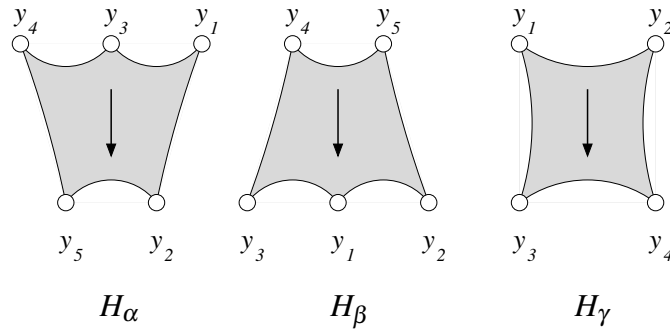

Figure 20 – The digraphs from  $\mathcal{H}$ . (This figure is a courtesy of (BANG-JENSEN; KRIESELL, 2011)).

**Theorem 3.8.4** (McCuaig (MCCUAIG, 1991)). *The class of intercyyclic digraphs in reduced form is  $\mathcal{T} \cup \{D_7\} \cup \mathcal{K} \cup \mathcal{H}$ .*

Using this characterization we can now prove the following.

**Corollary 3.8.5.** *If  $D$  is an intercyyclic oriented graph in reduced form, then  $\text{inv}(D) \leq 4$ .*

*Proof.* Let  $D$  be an intercyyclic oriented graph in reduced form. By Theorem 3.8.4, it is in  $\mathcal{T} \cup \{D_7\} \cup \mathcal{K} \cup \mathcal{H}$ .

If  $D \in \mathcal{T}$ , then it is obtained from a digraph  $D'$  in  $\mathcal{P}(x^+, y^+; x^-, y^-)$  by identifying  $x^+ = x^-$  and  $y^+ = y^-$ . Thus  $D - \{x^+, y^+\} = D' - \{x^+, y^+, x^-, y^-\}$  is acyclic. Hence  $\tau(D) \leq 2$ , and so by Theorem 3.4.1,  $\text{inv}(D) \leq 4$ .

If  $D = D_7$ , then inverting  $X_1 = \{y, y_2, y_4, y_6\}$  so that  $y$  becomes a sink and then inverting  $\{y_2, y_3, y_5, y_6\}$ , we obtain an acyclic digraph with acyclic ordering  $(y_3, y_6, y_4, y_5, y_1, y_2, y)$ . (See Figure 18.) Hence  $\text{inv}(D_7) \leq 2$ .

If  $D \in \mathcal{K}$ , then inverting  $\{x_0, x_3\}$  and  $\{x_0, x_1, x_2, x_3, w_1, z_1\}$ , we convert  $D$  to an acyclic digraph with acyclic ordering  $(x_3, x_2, x_1, x_0, v_1, \dots, v_p)$  where  $(v_1, \dots, v_p)$  is an acyclic ordering of  $K_H$ .

If  $D \in \mathcal{H}$ , then consider  $D' = \text{Inv}(D, V(H_\gamma))$ . The oriented graph  $D'$  is the union of  $H_\alpha \in \mathcal{P}(y_4, y_3, y_1; y_5, y_2)$ ,  $H_\beta \in \mathcal{P}(y_4, y_5; y_3, y_1, y_2)$ , and  $\overleftarrow{H}_\gamma$ , the converse of  $H_\gamma$ . As  $H_\gamma \in \mathcal{P}(y_1, y_2; y_3, y_4)$ , we have  $\overleftarrow{H}_\gamma \in \mathcal{P}(y_4, y_3; y_2, y_1)$ . Set  $Y = \{y_1, y_2, y_3, y_4, y_5\}$ .

We claim that every directed cycle  $C'$  of  $D'$  contains  $y_5$ . Since  $D' - Y$  is acyclic,  $C'$  is the concatenation of directed paths  $P_1, P_2, \dots, P_q$  with both end-vertices in  $Y$  and no internal vertex in  $Y$ . Now let  $C$  be the directed cycle obtained from  $C'$  by replacing each  $P_i$  by an arc from its initial vertex to its terminal vertex. Clearly,  $C$  contains  $y_5$  if and only if  $C'$  does.

But  $C$  is a directed cycle in  $J$  the digraph with vertex set  $Y$  in which  $\{y_4, y_3, y_1\} \rightarrow \{y_5, y_2\}$ ,  $\{y_4, y_5\} \rightarrow \{y_3, y_1, y_2\}$ , and  $\{y_4, y_3\} \rightarrow \{y_1, y_2\}$ . One easily checks that  $J - v_5$  is acyclic with acyclic ordering  $(y_4, y_3, y_1, y_2)$ , so  $C$  contains  $y_5$  and so does  $C'$ .

Consequently,  $\{y_5\}$  is a cycle transversal of  $D'$ . Hence, by Theorem 3.4.1, we have  $\text{inv}(D') \leq 2\tau(D') \leq 2$ . As  $D'$  is obtained from  $D$  by inverting one set, we get  $\text{inv}(D) \leq 3$ .  $\square$

We can now prove Theorem 3.8.1.

*Proof.* By induction on the number of vertices of  $D$ , the result holding trivially if  $|V(D)| = 3$ , that is  $D = \vec{C}_3$ .

Assume now that  $|V(D)| > 3$ .

If  $D$  is not strong, then it has a unique non-trivial strong component  $C$  and any decycling family of  $C$  is a decycling family of  $D$ , so  $\text{inv}(C) = \text{inv}(D)$ . By the induction hypothesis,  $\text{inv}(C) \leq 4$ , so  $\text{inv}(D) \leq 4$ . Henceforth, we may assume that  $D$  is strong.

Assume now that  $D$  has a weak arc  $a$ . If  $a$  is non-contractable, then  $\text{inv}(D) \leq 4$  by Lemma 3.8.3. If  $a$  is contractable, then consider  $\tilde{D}/a$ . As observed by McCuaig (MCCUAIG, 1991),  $D/a$  is also intercylic. So by Lemma 3.8.2 and the induction hypothesis,  $\text{inv}(D) \leq \text{inv}(D/a) \leq 4$ . Henceforth, we may assume that  $D$  has no weak arc.

Thus  $D$  is in a reduced form and by Corollary 3.8.5,  $\text{inv}(D) \leq 4$ .  $\square$

### 3.9 Complexity results on the inversion number

In this section we discuss the complexity of  $k$ -INVERSION and  $k$ -TOURNAMENT-INVERSION problems.

#### 3.9.1 NP-hardness of 1-INVERSION and 2-INVERSION

**Theorem 3.9.1.** 1-INVERSION is NP-complete even when restricted to strong oriented graphs.

In order to prove this theorem, we need some preliminaries. Let  $J$  be the oriented graph depicted in Figure 21.

**Lemma 3.9.2.** The only sets whose inversion can make  $J$  acyclic are  $\{a, b, e\}$  and  $\{b, c, d\}$ .

*Proof.* Assume that an inversion on  $X$  makes  $J$  acyclic. Then  $X$  must contain exactly two vertices of each of the directed 3-cycles  $(a, b, c, a)$ ,  $(a, b, d, a)$ , and  $(e, b, c, e)$ , and cannot be  $\{a, c, d, e\}$

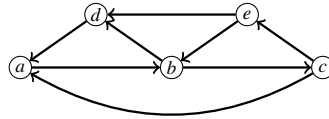

Figure 21 – The oriented graph  $J$  (Source: (BANG-JENSEN *et al.*, 2022)).

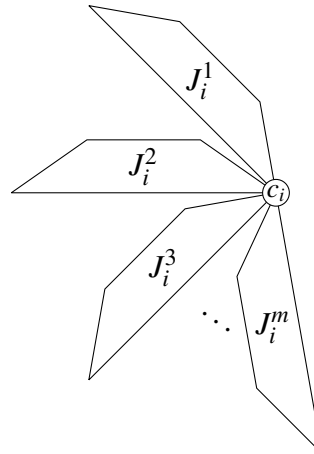

Figure 22 – The variable gadget  $K_i$  (Source: (BANG-JENSEN *et al.*, 2022)).

for otherwise  $(e, b, d, e)$  is a directed cycle in the resulting oriented graph. Hence  $X$  must be either  $\{a, b, e\}$  or  $\{b, c, d\}$ . One can easily check that an inversion on any of these two sets makes  $J$  acyclic.  $\square$

*Proof of Theorem 3.9.1.* Reduction from MONOTONE 1-IN-3 SAT which is well-known to be NP-complete.

Let  $\Phi$  be a monotone 3-SAT formula with variables  $x_1, \dots, x_n$  and clauses  $C_1, \dots, C_m$ . Let  $D$  be the oriented graph constructed as follows. For every  $i \in [n]$ , let us construct a variable digraph  $K_i$  as follows: for every  $j \in [m]$ , create a copy  $J_i^j$  of  $J$  with vertices  $\{a_i^j, b_i^j, c_i^j, d_i^j, e_i^j\}$ , and then identify all the vertices  $c_i^j$  into one vertex  $c_i$  as depicted in Figure 22. Then, for every clause  $C_j = x_{i_1} \vee x_{i_2} \vee x_{i_3}$ , we add the arcs of the directed 3-cycle  $D_j = (a_{i_1}^j, a_{i_2}^j, a_{i_3}^j)$ .

Observe that  $D$  is strong. We shall prove that  $\text{inv}(D) = 1$  if and only if  $\Phi$  admits a 1-in-3-SAT assignment.

Assume first that  $\text{inv}(D) = 1$ . Let  $X$  be a set whose inversion makes  $D$  acyclic. By Lemma 3.9.2, and the fact that the vertices  $c_i^j$  are identified in  $c_i$ , for every  $i \in [n]$ , either  $X \cap V(K_i) = \bigcup_{j=1}^m \{a_i^j, b_i^j, e_i^j\}$  or  $X \cap V(K_i) = \bigcup_{j=1}^m \{b_i^j, c_i, d_i^j\}$ . Let  $\varphi$  be the truth assignment



defined by  $\varphi(x_i) = \text{true}$  if  $X \cap V(K_i) = \bigcup_{j=1}^m \{b_i^j, c_i, d_i^j\}$ , and  $\varphi(x_i) = \text{false}$  if  $X \cap V(K_i) = \bigcup_{j=1}^m \{a_i^j, b_i^j, e_i^j\}$ .

Consider a clause  $C_j = x_{i_1} \vee x_{i_2} \vee x_{i_3}$ . Because  $D_j$  is a directed 3-cycle,  $X$  contains exactly two vertices in  $V(D_j)$ . Let  $\ell_1$  and  $\ell_2$  be the two indices of  $\{i_1, i_2, i_3\}$  such that  $a_{\ell_1}^j$  and  $a_{\ell_2}^j$  are in  $X$  and  $\ell_3$  be the third one. By our definition of  $\varphi$ , we have  $\varphi(x_{\ell_1}) = \varphi(x_{\ell_2}) = \text{false}$  and  $\varphi(x_{\ell_3}) = \text{true}$ . Therefore,  $\varphi$  is a 1-in-3 SAT assignment.

Assume now that  $\Phi$  admits a 1-in-3 SAT assignment  $\varphi$ . For every  $i \in [n]$ , let  $X_i = \bigcup_{j=1}^m \{b_i^j, c_i, d_i^j\}$  if  $\varphi(x_i) = \text{true}$  and  $X_i = \bigcup_{j=1}^m \{a_i^j, b_i^j, e_i^j\}$  if  $\varphi(x_i) = \text{false}$ , and set  $X = \bigcup_{i=1}^n X_i$ .

Let  $D'$  be the graph obtained from  $D$  by the inversion on  $X$ . We shall prove that  $D$  is acyclic, which implies  $\text{inv}(D) = 1$ .

Assume for a contradiction that  $D'$  contains a directed cycle  $C$ . By Lemma 3.9.2, there is no directed cycle in any variable gadget  $K_i$ , so  $C$  must contain an arc with both ends in  $V(D_j)$  for some  $j$ . Let  $C_j = x_{i_1} \vee x_{i_2} \vee x_{i_3}$ . Now since  $\varphi$  is a 1-in-3-SAT assignment, w.l.o.g., we may assume that  $\varphi(x_{i_1}) = \varphi(x_{i_2}) = \text{false}$  and  $\varphi(x_{i_3}) = \text{true}$ . Hence in  $D'$ ,  $a_{i_2}^j \rightarrow a_{i_1}^j$ ,  $a_{i_2}^j \rightarrow a_{i_3}^j$  and  $a_{i_3}^j \rightarrow a_{i_1}^j$ . Moreover, in  $D' \langle V(J_{i_1}^j) \rangle$ ,  $a_{i_1}^j$  is a sink, so  $a_{i_1}^j$  is a sink in  $D'$ . Therefore  $C$  does not go through  $a_{i_1}^j$ , and thus  $C$  contains the arc  $a_{i_2}^j a_{i_3}^j$ , and then enters  $J_{i_3}^j$ . But in  $D' \langle V(J_{i_3}^j) \rangle$ ,  $a_{i_3}^j$  has a unique out-neighbour, namely  $b_{i_3}^j$ , which is a sink. This is a contradiction.  $\square$

**Corollary 3.9.3.** 2-INVERSION is NP-complete.

*Proof.* By Corollary 3.6.5, we have  $\text{inv}(D \rightarrow D) = 2$  if and only if  $\text{inv}(D) = 1$ , so the statement follows from Theorem 3.9.1.  $\square$

### 3.9.2 Solving $k$ -TOURNAMENT-INVERSION for $k \in \{1, 2\}$

**Proposition 3.9.4.** 1-TOURNAMENT-INVERSION can be solved in  $O(n^3)$  time.

*Proof.* Let  $T$  be a tournament. For every vertex  $v$  one can check whether there is an inversion that transforms  $T$  into a transitive tournament with source  $v$ . Indeed, the inversion is the one on the closed in-neighbourhood of some  $v$ ,  $N^-[v] = N^-(v) \cup \{v\}$ . So one can make inversion on  $N^-[v]$  and check whether the resulting tournament is transitive. This can obviously be done in  $O(n^2)$  time.

Doing this for every vertex  $v$  yields an algorithm which solves 1-TOURNAMENT-INVERSION in  $O(n^3)$  time.  $\square$

**Theorem 3.9.5.** 2-TOURNAMENT-INVERSION can be solved in  $O(n^6)$  time.

The main idea to prove this theorem is to consider every pair  $(s, t)$  of distinct vertices and to check whether there are two sets  $X_1, X_2$  such that the inversion of  $X_1$  and  $X_2$  results in a transitive tournament with source  $s$  and sink  $t$ . We need some definitions and lemmas.

The **symmetric difference** of two sets  $A$  and  $B$  is  $A \triangle B = (A \setminus B) \cup (B \setminus A)$ .

Let  $T$  be a tournament and let  $s$  and  $t$  be two distinct vertices of  $T$ . We define the following four sets

$$A(s, t) = N^+(s) \cap N^-(t)$$

$$B(s, t) = N^-(s) \cap N^+(t)$$

$$C(s, t) = N^+(s) \cap N^+(t)$$

$$D(s, t) = N^-(s) \cap N^-(t)$$

**Lemma 3.9.6.** Let  $T$  be a tournament and let  $s$  and  $t$  be two distinct vertices of  $T$ . Assume there are two sets  $X_1, X_2$  such that the inversion of  $X_1$  and  $X_2$  results in a transitive tournament with source  $s$  and sink  $t$ .

- (1) If  $\{s, t\} \subseteq X_1 \setminus X_2$ , then  $ts \in A(T)$ ,  $C(s, t) = D(s, t) = \emptyset$  and  $X_1 = \{s, t\} \cup B(s, t)$ .
- (2) If  $s \in X_1 \setminus X_2$ ,  $t \in X_2 \setminus X_1$ , then  $st \in A(T)$ ,  $A(s, t) \cap (X_1 \cup X_2) = \emptyset$ ,  $X_1 = \{s\} \cup B(s, t) \cup D(s, t)$ , and  $X_2 = \{t\} \cup B(s, t) \cup C(s, t)$ .
- (3) If  $s \in X_1 \cap X_2$  and  $t \in X_1 \setminus X_2$ , then  $ts \in A(T)$ ,  $X_1 = \{s, t\} \cup B(s, t) \cup C(s, t)$ , and  $X_2 = \{s\} \cup C(s, t) \cup D(s, t)$ .
- (4) If  $\{s, t\} \subseteq X_1 \cap X_2$ , then  $st \in A(T)$ ,  $C(s, t) = \emptyset$ ,  $D(s, t) = \emptyset$ ,  $X_1 \cap X_2 \subseteq A(s, t) \cup \{s, t\}$ , and  $B(s, t) = X_1 \triangle X_2$ .

*Proof.* (1) The arc between  $s$  and  $t$  is reversed once, so  $ts \in A(T)$ .

Assume for a contradiction, that there is a vertex  $c \in C(s, t)$ . The arc  $tc$  must be reversed, so  $c \in X_1$ , but then the arc  $sc$  is reversed contradicting the fact that  $s$  becomes a source. Hence  $C(s, t) = \emptyset$ . Similarly  $D(s, t) = \emptyset$ .

The arcs from  $t$  to  $B(s, t)$  and from  $B(s, t)$  to  $s$  are reversed so  $B(s, t) \subseteq X_1$ . The arcs from  $s$  to  $A(s, t)$  and from  $A(s, t)$  to  $t$  are not reversed so  $A(s, t) \cap X_1 = \emptyset$ . Therefore  $X_1 = \{s, t\} \cup B(s, t)$ .

(2) The arc between  $s$  and  $t$  is not reversed, so  $st \in A(T)$ . The arcs from  $s$  to  $A(s,t)$  and from  $A(s,t)$  to  $t$  are not reversed so  $A(s,t) \cap X_1 = \emptyset$  and  $A(s,t) \cap X_2 = \emptyset$ . The arcs from  $t$  to  $B(s,t)$  and from  $B(s,t)$  to  $s$  are reversed so  $B(s,t) \subseteq X_1$  and  $B(s,t) \subseteq X_2$ . The arcs from  $s$  to  $C(s,t)$  are not reversed so  $C(s,t) \cap X_1 = \emptyset$  and the arcs from  $t$  to  $C(s,t)$  are reversed so  $C(s,t) \subseteq X_2$ . The arcs from  $D(s,t)$  to  $s$  are reversed so  $D(s,t) \subseteq X_1$  and the arcs from  $D(s,t)$  to  $d$  are not reversed so  $D(s,t) \cap X_2 = \emptyset$ . Consequently,  $X_1 = \{s\} \cup B(s,t) \cup D(s,t)$ , and  $X_2 = \{t\} \cup B(s,t) \cup C(s,t)$ .

(3) The arc between  $s$  and  $t$  is reversed, so  $ts \in A(T)$ . The arcs from  $A(s,t)$  to  $t$  are not reversed so  $A(s,t) \cap X_1 = \emptyset$ . The arcs from  $s$  to  $A(s,t)$  are not reversed so  $A(s,t) \cap X_2 = \emptyset$ . The arcs from  $t$  to  $B(s,t)$  are reversed so  $B(s,t) \subseteq X_1$ . The arcs from  $B(s,t)$  to  $s$  are reversed (only once) so  $B(s,t) \cap X_2 = \emptyset$ . The arcs from  $t$  to  $C(s,t)$  are reversed so  $C(s,t) \subseteq X_1$ . The arcs from  $s$  to  $C(s,t)$  must be reversed twice so  $C(s,t) \subseteq X_2$ . The arcs from  $D(s,t)$  to  $t$  are not reversed so  $D(s,t) \cap X_1 = \emptyset$ . The arcs from  $D(s,t)$  to  $s$  are reversed so  $D(s,t) \subseteq X_2$ . Consequently,  $X_1 = \{s,t\} \cup B(s,t) \cup C(s,t)$ , and  $X_2 = \{s\} \cup C(s,t) \cup D(s,t)$ .

(4) The arc between  $s$  and  $t$  is reversed twice, so  $st \in A(T)$ .

Assume for a contradiction, that there is a vertex  $c \in C(s,t)$ . The arc  $tc$  must be reversed, so  $c$  is in exactly one of  $X_1$  and  $X_2$ . But then the arc  $sc$  is reversed contradicting the fact that  $s$  becomes a source. Hence  $C(s,t) = \emptyset$ . Similarly  $D(s,t) = \emptyset$ . The arcs from  $s$  to  $A(s,t)$  and from  $A(s,t)$  to  $t$  are not reversed so every vertex of  $A(s,t)$  is either in  $X_1 \cap X_2$  or in  $V(T) \setminus (X_1 \cup X_2)$ . The arcs from  $t$  to  $B(s,t)$  and from  $B(s,t)$  to  $s$  are reversed so every vertex of  $B(s,t)$  is either in  $X_1 \setminus X_2$  or in  $X_2 \setminus X_1$ . Consequently,  $X_1 \cap X_2 \subseteq A(s,t) \cup \{s,t\}$ , and  $B(s,t) = X_1 \Delta X_2$ .  $\square$

**Lemma 3.9.7.** *Let  $T$  be a tournament of order  $n$  and let  $s$  and  $t$  be two distinct vertices of  $T$ .*

- (1) *One can decide in  $O(n^3)$  time whether there are two sets  $X_1, X_2$  such that the inversion of  $X_1$  and  $X_2$  results in a transitive tournament with source  $s$  and sink  $t$  and  $\{s,t\} \subseteq X_1 \setminus X_2$ .*
- (2) *One can decide in  $O(n^2)$  time whether there are two sets  $X_1, X_2$  such that the inversion of  $X_1$  and  $X_2$  results in a transitive tournament with source  $s$  and sink  $t$  and  $s \in X_1 \setminus X_2$  and  $t \in X_2 \setminus X_1$ .*
- (3) *One can decide in  $O(n^2)$  time whether there are two sets  $X_1, X_2$  such that the inversion of  $X_1$  and  $X_2$  results in a transitive tournament with source  $s$  and sink  $t$  and  $s \in X_1 \cap X_2$  and  $t \in X_1 \setminus X_2$ .*
- (4) *One can decide in  $O(n^4)$  time whether there are two sets  $X_1, X_2$  such that the inversion of  $X_1$  and  $X_2$  results in a transitive tournament with source  $s$  and sink  $t$  and  $\{s,t\} \subseteq X_1 \cap X_2$ .*

*Proof.* For all cases, we first compute  $A(s,t)$ ,  $B(s,t)$ ,  $C(s,t)$ , and  $D(s,t)$ , which can obviously be done in  $O(n^2)$ .

(1) By Lemma 3.9.6, we must have  $ts \in A(T)$  and  $C(s,t) = D(s,t) = \emptyset$ . So we first check if this holds. Furthermore, by Lemma 3.9.6, we must have  $X_1 = \{s,t\} \cup B(s,t)$ . Therefore we invert  $\{s,t\} \cup B(s,t)$  which results in a tournament  $T'$ . Observe that  $s$  is a source of  $T'$  and  $t$  is a sink of  $T'$ . Hence, we return ‘Yes’ if and only if  $\text{inv}(T' - \{s,t\}) = 1$  which can be tested in  $O(n^3)$  by Proposition 3.9.4.

(2) By Lemma 3.9.6, we must have  $st \in A(T)$ . So we first check if this holds. Furthermore, by Lemma 3.9.6, the only possibility is that  $X_1 = \{s\} \cup B(s,t) \cup D(s,t)$ , and  $X_2 = \{t\} \cup B(s,t) \cup C(s,t)$ . So we invert those two sets and check whether the resulting tournament is a transitive tournament with source  $s$  and sink  $t$ . This can be done in  $O(n^2)$ .

(3) By Lemma 3.9.6, we must have  $ts \in A(T)$ . So we first check if this holds. Furthermore, by Lemma 3.9.6, the only possibility is that  $X_1 = \{s,t\} \cup B(s,t) \cup C(s,t)$ , and  $X_2 = \{s\} \cup C(s,t) \cup D(s,t)$ . So we invert those two sets and check whether the resulting tournament is a transitive tournament with source  $s$  and sink  $t$ . This can be done in  $O(n^2)$ .

(4) By Lemma 3.9.6, we must have  $st \in A(T)$ ,  $C(s,t) = \emptyset$ ,  $D(s,t) = \emptyset$ . So we first check if this holds. Furthermore, by Lemma 3.9.6, the desired sets  $X_1$  and  $X_2$  must satisfy  $X_1 \cap X_2 \subseteq A(s,t) \cup \{s,t\}$ , and  $B(s,t) = X_1 \Delta X_2$ .

In particular, every arc of  $T_A = T\langle A(s,t) \rangle$  is either not reversed or reversed twice (which is the same). Hence  $T_A$  must be a transitive tournament. So we check whether  $T_A$  is a transitive tournament and if yes, we find a directed hamiltonian path  $P_A = (a_1, \dots, a_p)$  of it. This can be done in  $O(n^2)$ .

Now we check that  $B(s,t)$  admits a partition  $(X'_1, X'_2)$  with  $X'_i = X_i \cap B$  and the inversion of both  $X'_1$  and  $X'_2$  transforms  $T\langle B(s,t) \rangle$  into a transitive tournament  $T_B$  with source  $s'$  and sink  $t'$ . The idea is to investigate all possibilities for  $s'$ ,  $t'$  and the sets  $X'_1$  and  $X'_2$ . Since  $(X'_1, X'_2)$  is a partition of  $B(s,t)$  and  $(X'_1, X'_2)$  is a decycling family if and only if  $(X'_2, X'_1)$  is a decycling family, we may assume that

- (a)  $\{s', t'\} \subseteq X'_1 \setminus X'_2$ , or
- (b)  $s' \in X'_1 \setminus X'_2$  and  $t' \in X'_2 \setminus X'_1$ .

For the possibilities corresponding to Case (a), we proceed as in (1) above. For every arc  $t's' \in A(T\langle B(s,t) \rangle)$ , we check that  $C(s', t') = D(s', t') = \emptyset$  (where those sets are computed

in  $T\langle B(s,t) \rangle$ ). Furthermore, by Lemma 3.9.6, we must have  $X'_1 = \{s,t\} \cup B(s',t')$  and  $X'_2 = B(s,t) \setminus X'_1$ . So we invert those two sets and check whether the resulting tournament  $T_B$  is transitive. This can be done in  $O(n^2)$  (for each arc  $t's'$ ).

For the possibilities corresponding to Case (b), we proceed as in (2) above. For every arc  $t's' \in A(T\langle B(s,t) \rangle)$ , by Lemma 3.9.6, the only possibility is that  $X'_1 = \{s'\} \cup B(s',t') \cup D(s',t')$ , and  $X_2 = \{t'\} \cup B(s',t') \cup C(s',t')$ . As those two sets form a partition of  $B(s,t)$ , we also must have  $B(s',t') = \emptyset$  and  $A(s',t') = \emptyset$ . So we invert those two sets and check whether the resulting tournament  $T_B$  is transitive. This can be done in  $O(n^2)$  for each arc  $t's'$ .

In both cases, we are left with a transitive tournament  $T_B$ . We compute its directed hamiltonian path  $P_B = (b_1, \dots, b_q)$  which can be done in  $O(n^2)$ . We need to check whether this partial solution on  $B(s,t)$  is compatible with the rest of the tournament, that is  $\{s,t\} \cup A(s,t)$ . It is obvious that it will always be compatible with  $s$  and  $t$  as they become source and sink. So we have to check that we can merge  $T_A$  and  $T_B$  into a transitive tournament on  $A(s,t)$  and  $B(s,t)$  after the reversals of  $X_1$  and  $X_2$ . In other words, we must interlace the vertices of  $P_A$  and  $P_B$ . Recall that  $Z = X_1 \cap X_2 \setminus \{s,t\} \subseteq A(s,t)$  and  $X_i = X'_i \cup Z \cup \{s,t\}$ ,  $i \in [2]$  so the arcs between  $Z$  and  $B(s,t)$  will be reversed exactly once when we invert  $X_1$  and  $X_2$ . Using this fact, one easily checks that this is possible if and only there are integers  $j_1 \leq \dots \leq j_p$  such that

- either  $b_j \rightarrow a_i$  for  $j \leq j_i$  and  $b_j \leftarrow a_i$  for  $j > j_i$  (in which case  $a_i \notin Z$  and the arcs between  $a_i$  and  $B(s,t)$  are not reversed),
- or  $b_j \leftarrow a_i$  for  $j \leq j_i$  and  $b_j \rightarrow a_i$  for  $j > j_i$  (in which case  $a_i \in Z$  and the arcs between  $a_i$  and  $B(s,t)$  are reversed).

See Figure 23 for an illustration of a case when we can merge the two orderings after reversing  $X_1$  and  $X_2$ . The fat blue edges indicate that the final ordering will be  $b_1 - b_3, a_1 - a_4, b_4 - b_6, a_5 - a_8, b_7 - b_9, a_9 - a_{11}, b_{10} - b_{12}$ . The set  $Z = \{a_2, a_6, a_{10}\}$  consists of those vertices from  $A(s,t)$  which are in  $X_1 \cap X_2$ . These vertices are shown in red. The red arcs between a vertex of  $Z$  and one of the boxes indicate that all arcs between the vertex and those of the box have the direction shown. Hence the boxes indicate that values of  $j_1, \dots, j_{11}$  satisfy that :  $j_1 = \dots = j_4 = 3$ ,  $j_5 = \dots = j_8 = 6$ ,  $j_9 = \dots = j_{11} = 9$ .

Deciding whether there are such indices can be done in  $O(n^2)$  for each possibility.

As we have  $O(n^2)$  possibilities, and for each possibility the procedure runs in  $O(n^2)$  time, the overall procedure runs in  $O(n^4)$  time.  $\square$

*Proof of Theorem 3.9.5.* By Lemma 3.2.2, by removing iteratively the sources and sinks of the

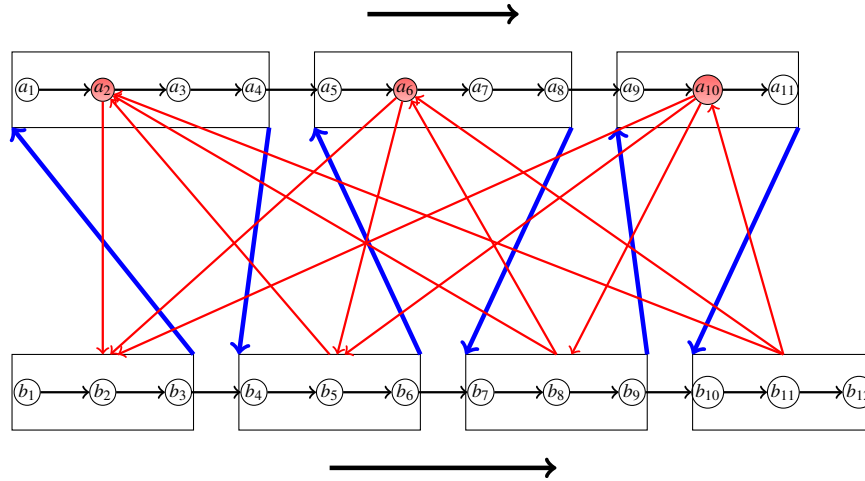

Figure 23 – Indicating how to merge the two orderings of  $A$  and  $B$  (Source: (BANG-JENSEN *et al.*, 2022)).

tournament, it suffices to solve the problem for a tournament with no sink and no source.

Now for each pair  $(s, t)$  of distinct vertices, one shall check whether there are two sets  $X_1, X_2$  such that the inversion of  $X_1$  and  $X_2$  results in a transitive tournament with source  $s$  and sink  $t$ . Observe that since  $s$  and  $t$  are neither sources nor sinks in  $T$ , each of them must belong to at least one of  $X_1, X_2$ . Therefore, without loss of generality, we are in one of the following possibilities:

- $\{s, t\} \subseteq X_1 \setminus X_2$ . Such a possibility can be checked in  $O(n^3)$  by Lemma 3.9.7 (1).
- $s \in X_1 \setminus X_2$  and  $t \in X_2 \setminus X_1$ . Such a possibility can be checked in  $O(n^2)$  by Lemma 3.9.7 (2).
- $s \in X_1 \cap X_2$  and  $t \in X_1 \setminus X_2$ . Such a possibility can be checked in  $O(n^2)$  by Lemma 3.9.7 (3).
- $t \in X_1 \cap X_2$  and  $s \in X_1 \setminus X_2$ . Such a possibility is the directional dual of the preceding one. It can be tested in  $O(n^2)$  by reversing all arcs and applying Lemma 3.9.7 (3).
- $\{s, t\} \subseteq X_1 \cap X_2$ . Such a possibility can be checked in  $O(n^4)$  by Lemma 3.9.7 (4).

Since there are  $O(n^2)$  pairs  $(s, t)$  and for each pair the procedure runs in  $O(n^4)$ , the algorithm runs in  $O(n^6)$  time.  $\square$

### 3.9.3 Computing related parameters when the inversion number is bounded

We recall that the transversal number, arc-transversal number and cycle packing number of a digraph are denoted by the symbols  $\tau$ ,  $\tau'$ , and  $\nu$ , respectively. Related to these

parameters, the aim of this subsection is to prove the following theorem.

**Theorem 3.9.8.** *Let  $\gamma$  be a parameter in  $\tau, \tau', \nu$ . Given an oriented graph  $D$  with inversion number 1 and an integer  $k$ , it is NP-complete to decide whether  $\gamma(D) \leq k$ .*

Let  $D$  be a digraph. The **second subdivision** of  $D$  is the oriented graph  $S_2(D)$  obtained from  $D$  by replacing every arc  $a = uv$  by a directed path  $P_a = (u, x_a, y_a, u)$  where  $x_a, y_a$  are two new vertices.

**Lemma 3.9.9.** *Let  $D$  be a digraph.*

- (i)  $\text{inv}(S_2(D)) \leq 1$ .
- (ii)  $\tau'(S_2(D)) = \tau'(D)$ ,  $\tau(S_2(D)) = \tau(D)$ , and  $\nu(S_2(D)) = \nu(D)$ .

*Proof.* (i) Inverting the set  $\bigcup_{a \in A(D)} \{x_a, y_a\}$  makes  $S_2(D)$  acyclic. Indeed the  $x_a$  become sinks, the  $y_a$  become sources and the other vertices form a stable set. Thus  $\text{inv}(S_2(D)) = 1$ .

(ii) There is a one-to-one correspondence between directed cycles in  $D$  and directed cycles in  $S_2(D)$  (their second subdivision). Hence  $\nu(S_2(D)) = \nu(D)$ .

Moreover every cycle transversal  $S$  of  $D$  is also a cycle transversal of  $S_2(D)$ . So  $\tau(S_2(D)) \leq \tau(D)$ . Now consider a cycle transversal  $T$ . If  $x_a$  or  $y_a$  is in  $T$  for some  $a \in A(D)$ , then we can replace it by any end-vertex of  $a$ . Therefore, we may assume that  $T \subseteq V(D)$ , and so  $T$  is a cycle transversal of  $D$ . Hence  $\tau(S_2(D)) = \tau(D)$ .

Similarly, consider a cycle arc-transversal  $F$  of  $D$ . Then  $F' = \{a \mid x_a y_a \in F\}$  is a cycle arc-transversal of  $S_2(D)$ . Conversely, consider a cycle arc-transversal  $F'$  of  $S_2(D)$ . Replacing each arc incident to  $x_a, y_a$  by  $x_a y_a$  for each  $a \in A(D)$ , we obtain another cycle arc-transversal. So we may assume that  $F' \subseteq \{x_a y_a \mid a \in A(D)\}$ . Then  $F = \{a \mid x_a y_a \in F'\}$  is a cycle arc-transversal of  $D$ . Thus  $\tau'(S_2(D)) = \tau'(D)$ .  $\square$

*Proof of Theorem 3.9.8.* Since computing each of  $\tau, \tau', \nu$  is NP-hard, Lemma 3.9.9 (ii) implies that computing each of  $\tau, \tau', \nu$  is also NP-hard for second subdivisions of digraphs. As those oriented graphs have inversion number 1 (Lemma 3.9.9 (i)), computing each of  $\tau, \tau', \nu$  is NP-hard for oriented graphs with inversion number 1.  $\square$

## 4 B-GREEDY COLOURINGS, Z-COLOURINGS AND ASSOCIATED PARAMETERS

### 4.1 Graph colourings and colouring heuristics

A **proper colouring** of a graph  $G$  is a function  $\phi : V(G) \rightarrow C$ , where  $C$  is a set of **colours** and such that for any edge  $uv \in E(G)$ ,  $\phi(u) \neq \phi(v)$ . Since we only deal with proper colourings, we will omit the term proper. In other words, we give to each vertex a colour in a way that neighbours have distinct colours. If  $|C| = k$  and  $\phi$  is surjective, we say that  $\phi$  is a  **$k$ -colouring**. We usually consider the set of colours  $C = \{1, 2, \dots, k\}$ . In Figure 24, we have two colourings  $\phi_1$  and  $\phi_2$  of the same graph. In particular,  $\phi_1$  is trivial since every vertex is assigned with a different colour.



Figure 24 – A 4-colouring and a 3-colouring of a graph.

A  **$k$ -colouring** may also be seen as a partition of the vertex set of  $G$  into  $k$  disjoint **stable sets** (i.e. sets of pairwise non-adjacent vertices)  $S_i = \{v \mid \phi(v) = i\}$  for  $1 \leq i \leq k$ . For convenience (and with a slight abuse of terminology), by  $k$ -colouring we mean both the mapping  $\phi$  or the partition  $(S_1, \dots, S_k)$ . The sets  $S_i$ ,  $1 \leq i \leq k$ , are the **colour classes**. A graph is  **$k$ -colourable** if it admits a  $k$ -colouring.

Given a graph  $G$  and a natural  $k < n$ , it is not always true that  $G$  is  $k$ -colourable. For example, the graph from Figure 24 is not 2-colourable. We define then the **chromatic number**  $\chi(G)$  as the least  $k$  such that  $G$  is  $k$ -colourable.

The problem of determining the chromatic number is one of Karp's twenty one NP-hard problems (KARP, 1972). It is already NP-complete to decide whether a given planar 4-regular graph admits a 3-colouring (DAILEY, 1980). Moreover, assuming  $P \neq NP$ , there is no algorithm that approximates the chromatic number within a factor of  $n^{1-\epsilon}$ , for all  $\epsilon > 0$  (ZUCKERMAN, 2007). This is a very strong limitation on the designing of approximation algorithms because it means that we cannot build a polynomial algorithm that colours  $G$  with  $\chi_{\mathcal{A}}(G)$  colours such that  $\chi_{\mathcal{A}}(G)/\chi(G) \leq n^{1-\epsilon}$ , for all  $\epsilon > 0$  and assuming  $P \neq NP$ . Thus, we should not expect any constant approximation factor for  $\chi(G)$  which even more curious if we



consider that  $\chi(G) \leq n$ .

#### 4.1.1 Greedy colourings and b-colourings

Due to the hardness of finding a colouring with the minimum number of colours there are a number of heuristics to find colourings. The most basic and most widespread one is the **greedy algorithm**.

---

**Algorithm 3:** Greedy algorithm:  $greedyAlg(G)$

---

**Input:** A graph  $G$

- 1: Label as  $v_1, v_2, \dots, v_n$  the vertices in  $V(G)$
  - 2: **for**  $i = 1, 2, \dots, n$  **do**
  - 3:    $c \leftarrow$  the minimum colour in  $[n]$  not used in  $N(v_i)$
  - 4:    $\phi(v_i) \leftarrow c$
  - 5: **end for**
  - 6: **return**  $\phi$
- 

Basically, the greedy algorithm go through the vertices assigning to  $v_i$  the smallest positive integer not already used on its lowered-indexed neighbours. The number of colours used by this heuristic depends on the ordering on which the vertices are processed (in Algorithm 3, this order is defined by the labeling given in line 1). In Figure 25, we have two possible outcomes of the greedy algorithm for the same graph. If the vertices are processed in the order  $a, e, b, f, c, g, d, h$ , a 4-colouring is found (Figure 25a). Processing the vertices in alphabetic order results in a 2-colouring (Figure 25b), which is the best possible. Indeed, it is known that for every graph there is an ordering such that the greedy algorithm will return an optimal colouring.

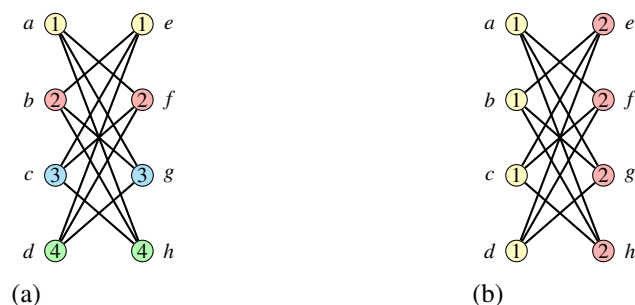

Figure 25 – Two possible outputs of the greedy algorithm.

A **greedy colouring** is a colouring that can be obtained by the greedy algorithm. A

vertex  $v$  is **greedy** with respect to some colouring  $\phi$  if it has least one neighbour of every colour in  $\{1, 2, \dots, \phi(v) - 1\}$ . A greedy colouring can also be defined as a colouring on which every vertex is greedy. The **Grundy number** of a graph  $G$ , denoted by  $\Gamma(G)$ , is the largest  $k$  such that  $G$  has a greedy  $k$ -colouring (CHRISTEN; SELKOW, 1979). It can be seen as a measure of the worst-case behaviour of the greedy algorithm. For an interested reader, here is a list of papers on the Grundy number of graphs: (BEYER *et al.*, 1982; EFFANTIN; KHEDDOUCI, 2003; ZAKER, 2005; ZAKER, 2006; EFFANTIN; KHEDDOUCI, 2007; KORTSARZ, 2007; ASTÉ *et al.*, 2010; ARAUJO; SALES, 2012; TANG *et al.*, 2017). The example of Figure 25 indicates that the difference between  $\Gamma(G)$  and  $\chi(G)$  can be arbitrary large.

Observe that greedy colourings may also be seen as the result of the following local improvement technique. We start with an arbitrary colouring. If a colour class is empty, then we suppress it. Going from the lower-indexed colour class to the highest one, we check: If a vertex is not a greedy vertex, then we move it into a lower-indexed stable set in which it has no neighbours. Such a move is called a **greedy improvement**. For example, consider the 4-colouring of the graph depicted in Figure 26a. Note that  $u$  is the only non-greedy vertex and we can apply a greedy improvement moving it to the  $S_2$ . Now, the vertex  $v$  is no longer greedy (Figure 26b) and we can move it to  $S_3$  as in Figure 26c.

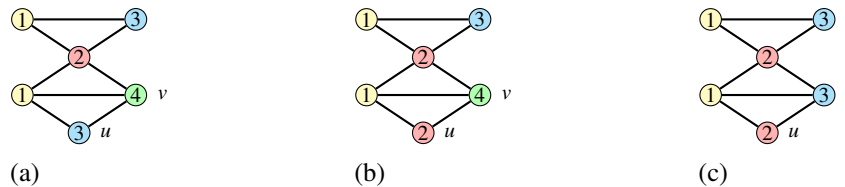

Figure 26 – Greedy improvement example. (a) A colouring  $\phi$  of a graph. (b) The colouring  $\phi'$  obtained from a greedy improvement of  $\phi$ . (c) The colouring obtained from a greedy improvement of  $\phi'$ .

For further reference we state this technique as the Algorithm 4. The running time of this algorithm is  $O(m)$ . For a non-greedy vertex, it suffices to visit its neighbours to compute the colour class it should go and this is done at most once for each vertex (lines 3 to 8 from Algorithm 4). Thus, we have at most  $\sum_{v \in V(G)} d(v) = 2m$  steps and therefore  $O(m)$  (or  $O(n)$  if  $G$  has more vertices than edges). We remark that, for convenience, from this point, we often treat colouring as its colour classes (or classes for short). Through this perspective, recolouring a vertex is equivalent to moving it to another class.

---

**Algoritmo 4:** Greedy improvement:  $greedyImp(G, (C_1, C_2, \dots, C_t))$ 

---

**Input:** A graph  $G$  and a  $t$ -colouring  $C_1, C_2, \dots, C_t$

**Output:** A greedy colouring  $C_1, C_2, \dots, C_{t'}$  with  $t' \leq t$

```

1:  $t' \leftarrow t$ 
2: for  $i = 2, 3, \dots, t'$  do
3:   for  $v \in C_i$  do
4:     if  $v$  is not greedy then
5:        $mc \leftarrow$  the minimum colour  $j \in \{1, 2, \dots, i-1\}$  such that  $v$  has no neighbours in  $C_j$ 
6:       move  $v$  to  $C_{mc}$ 
7:     end if
8:   end for
9:   if  $C_i = \emptyset$  then
10:     $t' \leftarrow t' - 1$ 
11:    for  $j = i, i+1, \dots, t' - 1$  do
12:       $C_j \leftarrow C_{j+1}$ 
13:    end for
14:  end if
15: end for
16: return  $C_1, C_2, \dots, C_{t'}$ 

```

---

Another well-known heuristic is based on a different improvement technique. Given a  $k$ -colouring  $(S_1, \dots, S_k)$ , a vertex of  $S_i$  is a **b-vertex** if it has a neighbour in  $S_j$  for all  $j \in [k] \setminus \{i\}$ . The local improvement is then the following: if there is a colour class  $S_i$  having no b-vertex, then we move every vertex of  $S_i$  into another colour class in which it has no neighbour and remove  $S_i$  (which has become empty). Such an improvement is called a **b-improvement**. On the colouring of Figure 27a, the class  $S_1$  has no b-vertex, so we can apply a b-improvement moving the vertices  $a, b$  and  $c$  to  $S_2, S_4$  (or  $S_2$ ) and  $S_4$  respectively, as we can see in Figure 27b.



Figure 27 – Example of a b-improvement. In (a), there is a colouring with no b-vertex of colour 1, so it is possible to perform a b-improvement moving the vertices from  $S_1$  to other classes. In (b), there is one of the two possibilities of b-improvement that can be performed from the colouring shown in (a).

A  **$k$ -b-colouring** is a  $k$ -colouring such that no b-improvement is possible, as the one of Figure 27b. In other words, it is a  $k$ -colouring such that every colour class has a b-vertex. The

worst case of this heuristic is the **b-chromatic number**  $\chi_b(G)$ , that is, the largest  $k$  such that  $G$  has a  $k$ -b-colouring. Since it was defined in (IRVING; MANLOVE, 1999), the b-chromatic number has been studied in many papers. Here is a small list: (KOUIDER; MAHÉO, 2002; KRATOCHVÍL *et al.*, 2002; CORTEEL *et al.*, 2005; KOUIDER; ZAKER, 2006a; JAKOVAC; KLAVŽAR, 2010; CABELLO; JAKOVAC, 2011; AMINE *et al.*, 2015; CAMPOS *et al.*, 2015; JAKOVAC; PETERIN, 2018).

Both the Grundy number and b-chromatic number are bounded by the maximum degree of the graph plus one. We formalize these bounds in the next proposition, but since this is an easy and well-known result, for simplicity, we will use it during the text without the concern of making reference to this proposition.

**Proposition 4.1.1** (Folklore). *For any graph  $G$ ,  $\Gamma(G) \leq \Delta(G) + 1$  and  $\chi_b(G) \leq \Delta(G) + 1$ .*

*Proof.* Let  $\phi(G)$  be a colouring of  $G$  and let  $v \in V(G)$  be a vertex of colour  $k$  in  $\phi$ . If  $v$  is a greedy vertex or a b-vertex, then it must have at least  $k - 1$  neighbours of distinct colours. Thus,  $\Gamma(G) \leq \Delta(G) + 1$  and therefore  $\chi_b(G) \leq \Delta(G) + 1$ .  $\square$

Observe that the example presented in Figure 25a is also a b-colouring and, if we generalize it, we can also conclude that the distance between  $\chi_b(G)$  and  $\chi(G)$  can be as large as we want, which is not a surprise since  $\chi(G)$  is not easy to approximate. However, greedy colourings are not always b-colourings and vice-versa. For example, the colouring of Figure 27a is greedy but not a b-colouring. For a fixed  $k$ , let  $kS_k$  be the disjoint union of  $k$  stars of order  $k$  (See Figure 28), the following result is a well-known example in which the distance between  $\Gamma$  and  $\chi_b$  can be arbitrarily large.

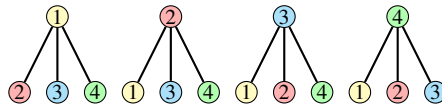

Figure 28 – A 4-b-colouring of a  $4S_4$ .

**Proposition 4.1.2** (Folklore). *For every  $k \geq 2$ ,  $\Gamma(kS_k) = 2$  and  $\chi_b(kS_k) = k$ .*

*Proof.* Let  $\phi$  be a greedy colouring of  $kS_k$  and let  $l$  be a leaf of  $kS_k$ . The vertex  $v$  has only one neighbour  $c$  which is the central vertex of correspondent star. Since  $v$  is greedy, either  $\phi(v) = 1$  and  $\phi(c) = 2$  or  $\phi(v) = 2$  and  $\phi(c) = 1$ . Thus, all the vertices of  $kS_k$  have colour 1 or 2 and

$\Gamma(kS_k) = 2$ . For the second part, we have that  $\chi_b(kS_k) \leq k$  because  $\Delta(kS_k) = k - 1$  so, in order to complete the proof, it suffices to show a  $k$ -b-colouring for  $kS_k$ . One may obtain such b-colouring by colouring each central vertex with a different colour in  $[k]$  and the leaves of its respective star with the  $k - 1$  remaining colours.  $\square$

#### 4.1.2 *b-greedy-colourings and z-colourings*

Greedy colourings and b-colourings were vastly studied separately and there are some works studying both the parameters  $\Gamma$  and  $\chi_b$  such as (HAVET; SAMPAIO, 2013) and (SAMPAIO, 2012), where there are some complexity results on computing them and more recent papers on establishing relations between them like in (MASIH; ZAKER, 2021) and (MASIH; ZAKER, 2022). But, as far as we know, Zaker (ZAKER, 2020) was the first one to combine both colourings into a single heuristic. Such a heuristic yields **b-greedy colourings** which are colourings that are both greedy colourings and b-colourings.

Consider the colourings depicted in Figure 29. In (a), we have a greedy 5-colouring which is not a b-colouring because there are no b-vertices of colours 1, 2 and 3. In fact, this particular graph does not admit a 5-b-colouring. In (b), observe that the vertices  $j, c, b, g$  are b-vertices of the colours 1, 2, 3, 4 respectively, and the vertices  $e, h, k$  are non greedy vertices. Therefore, here we have a b-colouring which is not greedy. Finally, in (c), we have an example of a b-greedy colouring. Note that every vertex is greedy and each colour has at least one b-vertex (e. g.  $g, b, i, j$ ).

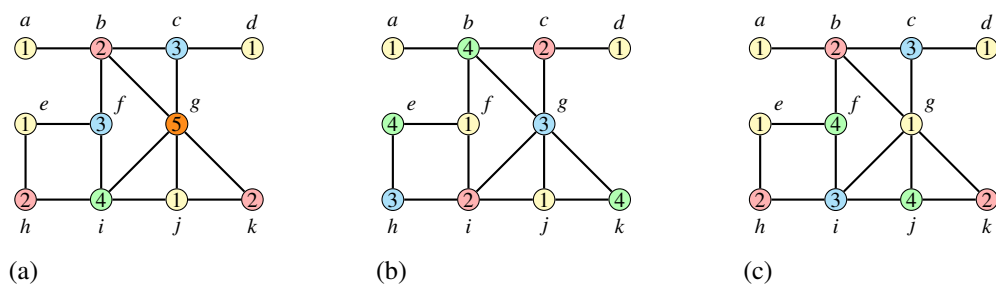

Figure 29 – Three different types of colourings of the same graph: greedy colouring (a), b-colouring (b), b-greedy colouring (c). Observe that to obtain the greedy colourings of (a) and (c), the vertices were not processed in alphabetic order.

Zaker showed that any greedy  $t$ -colouring can be improved into a b-greedy  $k$ -colouring with  $k \leq t$ . His proof can be turned into an algorithm (Algorithm 5) that runs in

time  $O(m)$ .

---

**Algorithm 5:** b-Greedy improvement:  $b\text{-greedyImp}(G, (C_1, C_2, \dots, C_k))$

---

**Input:** A graph  $G$  and a greedy colouring  $C_1, C_2, \dots, C_k$

**Output:** A b-greedy colouring  $C_1, C_2, \dots, C_{k'}$  with  $k' \leq k$

```

1:  $k' \leftarrow k$ 
2: for  $i = k - 2, k - 3, \dots, 1$  do
3:   if  $C_i$  has no b-vertex then
4:     for  $v \in C_i$  do
5:        $mc \leftarrow \min\{j : j \in \{i + 1, \dots, k' - 1, k'\} \text{ and } v \text{ has no neighbour in } C_j\}$ 
6:       move  $v$  to  $C_{mc}$ 
7:     end for
8:     for  $j = i, i + 1, \dots, k' - 1$  do
9:        $C_j \leftarrow C_{j+1}$ 
10:    end for
11:     $k' \leftarrow k' - 1$ 
12:  end if
13: end for
14: return  $C_1, C_2, \dots, C_{k'}$ 

```

---

**Proposition 4.1.3.** *Algorithm 5 returns a b-greedy colouring. Furthermore it runs in time  $O(m)$ .*

*Proof.* First, observe that in a given greedy colouring  $C_1, C_2, \dots, C_k$ , every vertex in  $C_k$  is a b-vertex and there is at least one b-vertex in  $C_{k-1}$ .

If every other class also has a b-vertex, the test of line 3 will always fail and the algorithm will return the input colouring, which was already b-greedy.

Otherwise, let  $i$  be the largest colour such that  $C_i$  has no b-vertex, that is, the first iteration of the main loop on which the test of line 3 does not fail. In this case, the loop from lines 4 to 7 will perform a b-improvement. This is done by recolouring every vertex  $v \in C_i$  with the smallest colour  $mc$  in which  $v$  has no neighbours in  $C_{mc}$ . Since  $v$  is a greedy vertex, it follows that  $mc \in \{i + 1, \dots, k - 1, k\}$ , and the choice of  $mc$  assures that  $v$  will keep the greedy property after the improvement. After this, the class  $C_i$  becomes empty and every vertex in  $C_{i+1} \cup C_{i+2} \dots \cup C_k$  will have its colour decreased by 1 (lines 8 to 11). At this point, we have a greedy  $k'$ -colouring such that all the classes  $C_k', C_k' - 1, \dots, C_i$  have b-vertices and  $k' = k - 1$  and we may apply these arguments again considering  $C_1, C_2, \dots, C_{k'}$ . Thus, for every value of the variable  $i$  on the main loop (lines 2 to 13), the algorithm keeps as invariant a greedy  $k'$ -colouring on which the classes  $C_{i+1}, C_{i+2}, \dots, C_{k'}$  all have b-vertices. At the last iteration ( $i = 1$ ) either  $C_1$  has a b-vertex and then the algorithm will return the current colouring or it will perform a b-improvement and

eliminate  $C_1$ , as we argued before, and return the modified colouring. In both cases, it returns a b-greedy colouring. Similar to Algorithm 4, each vertex will be scanned once and one search through its neighbours suffices to compute  $mc$ , which gives at most  $\sum_{v \in V(G)} d(v) = 2m$  steps. Hence, the algorithm runs in time  $O(m)$  (or  $O(n)$  if the number of vertices is much larger than  $m$ ).  $\square$

Let  $C$  be a  $k$ -colouring of a graph  $G$ . A vertex  $v \in V(G)$  is a **nice vertex** for  $C$  if it has colour  $k$  and it is adjacent to at least  $k - 1$  b-vertices of distinct colours. In (ZAKER, 2020), Zaker showed that every b-greedy  $p$ -colouring can be improved (in polynomial time) into a b-greedy  $q$ -colouring having at least one nice vertex and with  $q \leq p$ . Such a  $q$ -colouring is called a  **$q$ -z-colouring**. We say that the **b-Grundy number**  $\Gamma_b(G)$  is the largest  $k$  such that  $G$  has a b-greedy  $k$ -colouring and, in its turn, the **z-number**  $z(G)$  is the largest  $k$  such that  $G$  has a  $k$ -z-colouring. Zaker did not define nor study the b-Grundy number in (ZAKER, 2020); he focused on z-colourings and, consequently, the z-number. However, b-greedy colourings can be seen as independent heuristic (from which z-colourings are a refinement) and we considered that studying  $\Gamma_b$  could be useful. First, it is an upper bound for the z-number, and second, we believe it may be easier to adapt results from greedy and b-colourings directly to b-greedy colourings.

The b-greedy colouring presented in Figure 29c has no nice vertex since the vertex  $j$  sees no b-vertex of colour 2 and the vertex  $f$  sees no b-vertex of colour 1, and therefore this is not a z-colouring. Applying Zaker's technique described in the proof of the next theorem to this colouring, we can obtain the z-colouring depicted in Figure 30d.

**Theorem 4.1.4.** (ZAKER, 2020) *Let  $G$  be a graph and  $C$  be a b-greedy  $t$ -colouring. There is an procedure that converts  $C$  into a z-colouring with  $k$  colours for some  $k$  such that  $k \leq t$ . Furthermore, this can be done in  $O(nm)$  steps.*

*Proof.* Let  $C = C_1, \dots, C_t$  be the given b-greedy colouring from the statement. If there is some nice vertex in  $C_t$ , we are done. Otherwise, for every  $u \in C_t$ , there is a minimum colour  $bc(u)$  such that  $u$  is not neighbour of any b-vertex of colour  $bc(u)$ . Let  $v$  be a vertex of colour  $t$ . We will move  $v$  from  $C_t$  to  $C_{bc(v)}$ , but since  $v$  has at least one neighbour in  $C_{bc(v)}$ , we will need to its neighbours too. Then, for every neighbour  $w$  of  $v$  of colour  $bc(v)$ , let  $tc(w)$  be the smallest colour such that  $w$  has no neighbour in  $C_{tc(w)}$ , that is, the maximum colour that we can recolour  $w$  so that it keeps the greedy property once we recolour  $v$  (ex. Figure 30a). Observe that  $tc(w)$  exists because  $w$  is not a b-vertex. So, the complete sequence is: we move  $v$  to  $C_{bc(v)}$  and then

we move  $w$  to  $C_{tc(w)}$ , for every  $w \in N(v) \cap C_{bc(v)}$ . Let  $C'$  be the colouring we obtain after these changes. Observe that  $C'$  may have lost the greedy properties or b-colouring properties, and therefore it may no longer be b-greedy (Figure 30b). We then apply Algorithms 4 and 5 to  $C'$  in order to obtain another b-greedy  $t'$ -colouring  $C''$ . It follows that either  $t' = t$  and therefore  $|C''_i| < |C_t|$  or  $t' < t$ . The first case happens when  $C'$  is already b-greedy and Algorithm 5 will not change  $C'$ . Thus, we can repeat the whole process from  $C''$  and  $C''_i$  and it will eventually find the desired colouring, and we cannot remove more than  $n$  colour classes before it happens (Figure 30d). Therefore the whole procedure will execute at most  $n$  times the Algorithm 5 which runs in  $O(m)$  time. Hence we have a total of  $O(nm)$  steps.  $\square$

In Figure 30, we give an example of the application of this procedure to the b-greedy colouring depicted in Figure 29c. Recall that, for a non-nice vertex  $v$ , the index  $bc(v)$  is the minimum colour in which  $v$  is not adjacent to none b-vertex in  $C_{bc(v)}$ . In its turn, for a non-b-vertex  $w$  of colour  $i$ ,  $tc(w)$  is the index of the minimum colour (other than  $i$ ) such that  $w$  has no neighbour of coloured  $tc(w)$ . Since this colouring has no nice vertex, we pick one vertex of maximum colour, in this case  $j$ , to recolour. The vertex  $j$  is neighbour of b-vertices of colour 1 and 3, so  $bc(j) = 2$ . Then, we compute  $tc(k)$  and we get 3. See Figure 30a. After recolouring  $j$  and  $k$ , we have the colouring depicted in Figure 30b which has no b-vertex of colour 1 and therefore is not b-greedy. Then, we apply the b-greedy improvement as described in Algorithm 5 and recolour the vertices in  $C_1$  (Figure 30c) and after we decrease every remaining colour by 1. The result is already a z-colouring as we can see in Figure 30d. Let  $G_{29}$  be the graph used in the examples of both Figures 29 and 30. We have that,  $\Gamma(G_{29}) = 5 > \chi_b(G_{29}) = \Gamma_b(G_{29}) = 4 > z(G_{29}) = 3 = \chi(G_{29})$ .

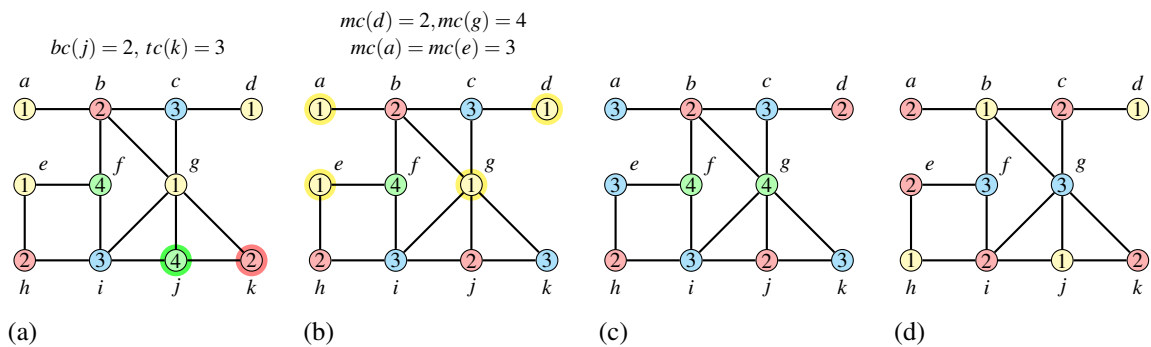

Figure 30 – Illustration of the application of Theorem’s 4.1.4 techniques to convert a b-greedy colouring (a) into a z-colouring (d).



The proof of Theorem 4.1.4 gives us an algorithm to find a z-colouring which follows in Algorithm 6.

---

**Algorithm 6:** z-improvement:  $z\text{-improvement}(G, (C_1, C_2, \dots, C_t))$

---

**Input:** A graph  $G$  and a b-greedy colouring  $C_1, C_2, \dots, C_t$

**Output:** A z-colouring  $C_1, C_2, \dots, C_{t'}$  with  $t' \leq t$

```

1:  $t' \leftarrow t$ 
2: while  $C_t'$  has no nice vertex do
3:    $v \leftarrow$  any vertex of  $C_t'$ 
4:   recolour  $v$  with the colour  $bc(v)$ 
5:   for  $w \in N(v) \cap C_{bc(v)}$  do
6:     recolour  $w$  with the colour  $tc(w)$ 
7:   end for
8:   let  $C'$  be the resulting colouring
9:    $C'' \leftarrow \text{greedyImp}(G, C')$  (Algorithm 4)
10:   $C'' \leftarrow b\text{-greedyImp}(G, C'')$  (Algorithm 5)
11:   $C \leftarrow C''$ 
12:   $t' \leftarrow$  the index of the larger colour of  $C''$ 
13: end while
14: return  $C_1, C_2, \dots, C_{t'}$ 

```

---

The complete z-colouring heuristic consists in computing an initial greedy colouring and then applying Algorithm 5 to obtain a b-greedy colouring and use it as an input of Algorithm 6 which will return the desired colouring. For the sake of completeness, we state this procedure as Algorithm 7.

---

**Algorithm 7:** z-colouring:  $z\text{-colouring}(G)$

---

**Input:** A graph  $G$

**Output:** A z-colouring  $C$

```

1:  $C^1 \leftarrow \text{greedyAlg}(G)$  (Algorithm 3)
2:  $C^2 \leftarrow b\text{-greedyImp}(G, C^1)$  (Algorithm 5)
3:  $C \leftarrow z\text{-improvement}(G, C^2)$  (Algorithm 6)
4: return  $C$ 

```

---

Now that we have established how to compute b-greedy colourings and z-colourings, we pass to the study their worst-case behaviours, that is, the b-Grundy number and z-number parameters. Recall that a **clique** in a graph is a set of pairwise adjacent vertices. We denote by  $\omega(G)$  the **clique number** of  $G$ , that is the size of a largest clique in  $G$ .

By definition, we have

$$\omega(G) \leq \chi(G) \leq z(G) \leq \Gamma_b(G) \leq \min\{\Gamma(G), \chi_b(G)\} \leq \Delta(G) + 1 \quad (4.1)$$

The chromatic number (resp. Grundy number) of a graph is well-known to be equal the maximum of the chromatic numbers (resp. Grundy numbers) of its connected components. The b-chromatic number is greater or equal to the maximum of the b-chromatic numbers of its connected components, but it can be arbitrarily larger. Consider for example the disjoint union of  $k$  stars of order  $k$ . Clearly, each connected component has b-chromatic number 2, but the whole graph has b-chromatic number  $k$  (colour each star with  $k$  different colours so that the  $k$  central vertices have different colours). Next, we show that the z-number of a graph is the maximum of the z-numbers of its connected components, and that its b-Grundy number is greater or equal to the maximum of the b-Grundy numbers of its connected components.

**Proposition 4.1.5.** *Let  $G$  be a graph.*

- (i)  $z(G) = \max\{z(C) \mid C \text{ connected component of } G\}$ .
- (ii)  $\Gamma_b(G) \geq \max\{\Gamma_b(C) \mid C \text{ connected component of } G\}$ .

*Proof.* (i) Set  $m = \max\{z(C) \mid C \text{ connected component of } G\}$ ,  $k = z(G)$ , and let  $C_1, \dots, C_p$  be the connected components of  $G$  such that  $m = z(C_1) \geq z(C_2) \geq \dots \geq z(C_p)$ .

For every  $i \in [p]$  of  $G$ , let  $\phi_i$  be a  $z(C_i)$ -z-colouring of  $C_i$ . Let  $\phi$  be the union of those colourings that is the colouring defined by  $\phi(v) = \phi_i(v)$  for all  $v \in V(C_i)$  and all  $i \in [p]$ . This is a greedy  $m$ -colouring because each  $\phi_i$  is greedy, and this is an  $m$ -b-colouring: all the b-vertices for  $\phi_1$  are also b-vertices for  $\phi$ . Furthermore, there is a b-vertex  $b_m$  in  $\phi_1$  which is adjacent to a b-vertex  $b_i$  of color  $i$ , for every colour  $i \in [m-1]$ , and therefore  $\phi$  is a z-colouring. Hence  $k \geq m$ .

Reciprocally, assume that  $\phi$  is a  $k$ -z-colouring of  $G$ . There exist b-vertices  $b_i$  coloured  $i$ ,  $i \in [k]$  such that  $b_k$  is adjacent to all  $b_j$ ,  $j \in [k-1]$ . All these vertices are contained in a same connected component  $C$  of  $G$ . Hence the restriction of  $\phi$  to  $C$  is a greedy  $k$ -colouring and a  $k$ -b-colouring with b-vertices  $b_i$ ,  $i \in [k]$ , thus a  $k$ -z-colouring. It follows that  $m \geq k$ .

(ii) Similarly to (i), setting  $m = \max\{\Gamma_b(C) \mid C \text{ connected component of } G\}$ , letting  $C_1, \dots, C_p$  be the connected components of  $G$  such that  $m = \Gamma_b(C_1) \geq \Gamma_b(C_2) \geq \dots \geq \Gamma_b(C_p)$ , one shows that the union of b-greedy  $\Gamma_b(C_i)$ -colouring of  $C_i$  is a b-greedy  $m$ -colouring of  $G$ .  $\square$

The inequality (ii) of Proposition 4.1.5 is not always an equality. Indeed consider the tree  $T_b$  depicted in Figure 31a. We have  $\Gamma_b(T_b) \leq \chi_b(T_b) \leq 3$  because  $T_b$  has only three vertices of degree 3 (and thus cannot have four b-vertices in a 4-colouring). On the other hand, in Figure we have a 4-b-greedy colouring for  $2T_b$  and therefore  $\Gamma_b(2T_b) = 4$ , where  $2T_b$  is the disjoint union of two copies of  $T_b$ .

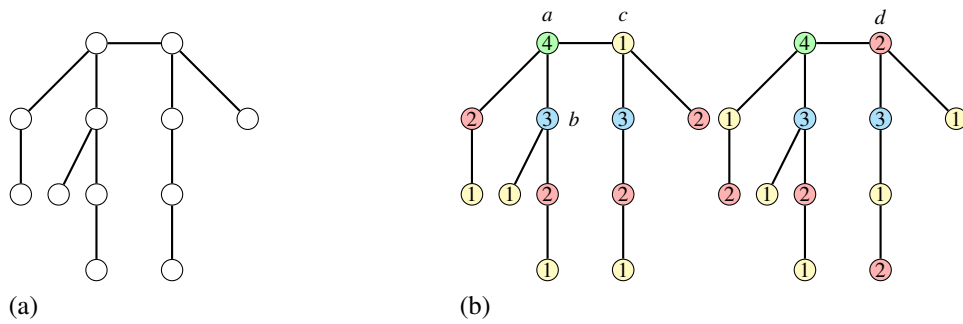

Figure 31 – The tree  $T_b$  (a) and a 4-b-greedy colouring for  $2T_b$  (b). The vertices  $a, b, c$  and  $d$  are b-vertices.

We consider now the z-spectrum and  $\Gamma_b$ -spectrum of a graph. The **z-spectrum** (resp.  **$\Gamma_b$ -spectrum**,  **$\Gamma$ -spectrum**,  **$\chi_b$ -spectrum**) of a graph  $G$ , denoted by  $\text{z-spec}(G)$  (resp.  $\Gamma_b\text{-spec}(G)$ ,  $\Gamma\text{-spec}(G)$ ,  $\chi_b\text{-spec}(G)$ ) is the set of values  $k$  such that  $G$  admits a z-colouring (resp. b-greedy colouring, Grundy colouring, b-colouring) with  $k$  colours. For a parameter  $\gamma$  in  $\{z, \Gamma_b, \Gamma, \chi_b\}$ , we say that  $G$  is  **$\gamma$ -continuous** if  $\gamma\text{-spec}(G) = \{\chi(G), \dots, \gamma(G)\}$ . It is well-known that every graph is  $\Gamma$ -continuous (see e.g. (HAVET *et al.*, 2022)) while many graphs are not  $\chi_b$ -continuous (see e.g. (JAKOVAC; PETERIN, 2018)).

In Proposition 4.1.6 we show a graph that is neither z-continuous nor  $\Gamma_b$ -continuous but, for the next results, we need to define the graphs  $M_k$  and  $N_k$ . Let  $M_k$  be the graph obtained from the bipartite complete graph with bipartition  $(X, Y)$  where  $X = \{x_1, \dots, x_k\}$  and  $Y = \{y_1, \dots, y_k\}$  by deleting the edges  $x_i y_i$  for all  $i \in [k]$ . In its turn, let  $N_k$  be the graph obtained from  $M_{k-1}$  by adding the edge  $x_{k-1} y_{k-1}$ . Although this last graph is built from  $M_{k-1}$ , we kept the name  $N_k$  because it admits a greedy  $k$ -colouring (Figure 32b) as  $M_k$  does (see Figure 25a). See Figure 32 for an example of these graphs with  $k = 4$ .



Figure 32 – The graphs  $M_4$ (a) and  $N_4$  (b) with a greedy 4-colouring.

The following proposition characterizes the  $z$ -spectrum and  $\Gamma_b$ -spectrum of  $M_k$ . It implies that  $M_k$  is neither  $z$ -continuous nor  $\Gamma_b$ -continuous for all  $k \geq 4$ .

**Proposition 4.1.6.**  $z\text{-spec}(M_k) = \Gamma_b\text{-spec}(M_k) = \chi_b\text{-spec}(M_k) = \{2, k\}$ .

*Proof.* It is well-known that  $\chi_b\text{-spec}(M_k) = \{2, k\}$ . Now, as every  $z$ -colouring is a  $b$ -greedy colouring which in turn is a  $b$ -colouring,  $z\text{-spec}(M_k) \subseteq \Gamma_b\text{-spec}(M_k) \subseteq \chi_b\text{-spec}(M_k) = \{2, k\}$ . But the colouring  $\phi_1$  that assigns colour  $i$  to  $x_i$  and  $y_i$  for all  $i \in [k]$ , and the colouring  $\phi_2$  that assigns 1 to all vertices in  $X$  and 2 to all vertices of  $Y$  are both  $z$ -colourings of  $M_k$ . Hence  $z\text{-spec}(M_k) = \Gamma_b\text{-spec}(M_k) = \chi_b\text{-spec}(M_k) = \{2, k\}$ .  $\square$

We mentioned before that  $N_k$  admits a greedy colouring with  $k$  colours, for example we can make  $\phi(y_{k-1}) = k$ ,  $\phi(x_{k-1}) = k-1$  and  $\phi(x_i) = \phi(y_i) = i$  for  $i \in [k-2]$  (see Figure (b)). Adding this to the fact that  $\Delta(N_k) = k-1$ , allow us to conclude that  $\Gamma(N_k) = k$ . On the other side, we have the following result.

**Proposition 4.1.7.**  $z(N_k) = \Gamma_b(N_k) = \chi_b(N_k) = 2$  for all integer  $k \geq 2$ .

*Proof.* Consider a  $b$ -colouring  $\phi$  of  $N_k$ . Every vertex of  $X \setminus \{x_{k-1}\}$  is adjacent to no vertex of colour  $\phi(x_{k-1})$ . Therefore, in  $X$ , there can only be  $b$ -vertices coloured  $\phi(x_{k-1})$ . Similarly, in  $Y$ , there can only be  $b$ -vertices coloured  $\phi(y_{k-1})$ . Hence, there can only be  $b$ -vertices of two different colours. So  $\phi$  is a 2-colouring.  $\square$

In light of propositions 4.1.6 and 4.1.7, it is natural to pose the following problem, which we will get back when answering positively for trees in Section 4.5:

**Problem 4.1.8.** *Which graphs are  $z$ -continuous? Which graphs are  $\Gamma_b$ -continuous?*

These last two propositions are also to prove the non-monotonicity of  $z$  and  $\Gamma_b$ . A graph parameter  $\gamma$  is said to be **monotone**, if  $\gamma(G) \geq \gamma(H)$  for every induced subgraph  $H$  of  $G$ . The Grundy number  $\Gamma$  is monotone (see (ASTÉ *et al.*, 2010)) while the  $b$ -chromatic number  $\chi_b$  is not (see e. g. (JAKOVAC; PETERIN, 2018)). We prove that neither  $z$  nor  $\Gamma_b$  is monotone.

**Corollary 4.1.9.**  *$z$  and  $\Gamma_b$  are not monotone.*

*Proof.*  $z(N_{k+1}) = \chi_b(N_{k+1}) = 2$  by Proposition 4.1.7. But  $N_{k+1}$  contains  $M_k$  and  $z(M_k) = \chi_b(M_k) = k$  by Proposition 4.1.6.  $\square$

In view of the chain of inequalities (4.1), it is natural to ask whether  $\Gamma_b(G)$  can be bounded by a function of  $z(G)$  and whether  $\min\{\Gamma(G), \chi_b(G)\}$  can be bounded by a function of  $\Gamma_b(G)$ . Zaker (ZAKER, 2020) proved that  $\min\{\Gamma(G), \chi_b(G)\}$  cannot be bounded by a function of  $z(G)$ : he showed that there are graphs  $G$  with  $z$ -number at most 3 for which  $\min\{\Gamma(G), \chi_b(G)\}$  can be arbitrarily large. We improved on Zaker's result and answer the second of the above-questions: we prove that there are graphs  $G$  with  $b$ -Grundy number at most 2 (and thus  $z$ -number at most 2) for which  $\min\{\Gamma(G), \chi_b(G)\}$  can be arbitrarily large. Recall that for any positive integer  $k$ , we denote by  $kG$  the disjoint union of  $k$  copies of  $G$ .

**Proposition 4.1.10.** *For every fixed  $k$ , there is a graph  $G_k$  such that  $z(G) = \Gamma_b(G_k) = 2$  and  $\min\{\Gamma(G), \chi_b(G)\} = k$ .*

*Proof.* Let  $S_k$  be the star on  $k$  vertices and let  $G_k = N_k + kS_k$ . We argued before that  $\Gamma(N_k) = k$  and in Proposition 4.1.2 that  $\Gamma(kS_k) = 2$  and  $\chi_b(kS_k) = k$ . So, we have  $\Gamma(G_k) \geq \Gamma(N_k) = k$  and  $\chi_b(G_k) \geq \chi_b(kS_k) = k$ . Therefore, since  $\Delta(G_k) = k - 1$ , we have  $\Gamma(G_k) = \chi_b(G_k) = k$ .

Suppose now for a contradiction that  $G_k$  admits a  $b$ -greedy  $p$ -colouring  $\phi$  with  $p \geq 3$ . The restriction of this colouring to  $kS_k$  is a greedy colouring. Hence, because  $\Gamma(kS_k) = 2$ , only colour 1 and 2 appear on  $kS_k$ . In particular, there is no  $b$ -vertex in  $kS_k$ , so all the  $b$ -vertices are in  $N_k$ . Hence the restriction of  $\phi$  to  $N_k$  is a  $p$ - $b$ -colouring. This contradicts the fact that  $\chi_b(N_k) = 2$  by Proposition 4.1.7.  $\square$

However, the following question, which we positively answer this for trees in Section 4.5, remains open in general:

**Problem 4.1.11.** *Does there exist a function  $f$  such that  $\Gamma_b(G) \leq f(z(G))$  for all graph  $G$  ?*

Let us now establish an upper bound for the  $z$ -number of a graph  $G$ . Let  $m_z(G)$  be the largest integer  $i$  such that there is a vertex  $v \in V(G)$  having (at least)  $i$  neighbours with degree at least  $i$ .

**Lemma 4.1.12.**  $z(G) \leq m_z(G) + 1$ .

*Proof.* Let  $c$  be a  $k$ - $z$ -colouring. There is a vertex  $v_k$  with  $c(v) = k$  which is also adjacent to  $v_1, v_2, \dots, v_{k-1}$  where  $v_i$  is a  $b$ -vertex of colour  $i$  and therefore  $d(v_i) \geq k - 1$ , for every  $i \in [k - 1]$ . Thus,  $m_z(G) \geq k - 1$ . In particular, if  $k = z(G)$ , we have  $z(G) \leq m_z(G) + 1$ .  $\square$

## 4.2 NP-hardness

In this section we discuss some hardness results related to the b-Grundy number and the z-number.

Havet and Sampaio (HAVET; SAMPAIO, 2013) showed that deciding whether  $\Gamma(G) = \Delta(G) + 1$  for a given graph  $G$  is NP-complete even if  $G$  is bipartite. We now adapt their proof to show that the same holds for  $\Gamma_b$  and  $z$ .

**Theorem 4.2.1.** *It is NP-complete to decide whether a given bipartite graph  $G$  such that  $\Gamma(G) = \Delta(G) + 1$  satisfies  $\Gamma_b(G) = \Delta(G) + 1$  (resp.  $z(G) = \Delta(G) + 1$ ).*

*Proof.* We shall describe a reduction from 3-edge-colourability of cubic graphs which is NP-complete (LEVEN; GALIL, 1983) to the problem of deciding whether  $\Gamma_b(G) = \Delta(G) + 1$  (resp.  $z(G) = \Delta(G) + 1$ ) for a given bipartite graph  $G$ .

Let  $H$  be a cubic graph with  $t - 3$  vertices. We label the vertices and edges of  $H$  by  $v_4, v_5, \dots, v_t$  and  $e_1, e_2, \dots, e_p$ . Recall that  $M_k$  is the graph obtained from the complete bipartite graph  $K_{k,k}$  by removing a perfect matching. Let  $I$  be the graph with  $V(I) = V(H) \cup E(H)$  where there is an edge  $v_i e_j$  if and only if  $v_i$  is one of the end-vertices of  $e_j$  in  $H$ . Observe that  $V(H)$  and  $E(H)$  are independent sets in  $I$  and therefore  $I$  is bipartite.

Now we construct a bipartite graph  $G$  from  $I$  that has a b-greedy-colouring with  $\Delta(G) + 1$  colours if and only if  $H$  is 3-edge-colourable. For every  $j \in [p]$ , we take a copy  $M_3^{e_j}$  of  $M_3$  and identify  $e_j$  with one of its vertices. For every  $i \in \{5, 6, \dots, t\}$ , we add a copy  $M_j^i$  of  $M_j$  and connect  $v_i$  to one of its vertices  $v_j^i$ , for  $4 \leq j \leq i - 1$ . We also add a vertex  $r$  and the copies  $M_1^r, M_2^r, M_3^r$  of  $K_1, K_2, M_3$  along with the edges  $rv_4, rv_5, \dots, rv_t$  and  $rv_1^r, rv_2^r, rv_3^r$  where  $v_i^r$  is a vertex of  $M_i^r$ , for  $i \in [3]$ . We add a vertex  $s$  and, for every  $i \in [t]$ , we add a copy  $U_i$  of  $M_{t+1}$  and we chose an arbitrary vertex  $u_i$  of  $U_i$  to add the edge  $su_i$ . We finish the construction by adding the edge  $sr$ . See Figure 33. Let us argue why  $G$  is bipartite. All the gadgets we added in  $I$  (represented by rectangles in Figure 33) are bipartite and, except the rightmost ones, they connected with the other structures of  $G$  by a single edge. The later implies that there is no cycle going in and out of such gadgets, since there is no edge between two of them. For the rightmost gadgets  $(M_3^{e_1}, \dots, M_3^{e_p})$ , we have that only the vertices  $e_1, e_2, \dots, e_p$  could appear in an odd cycle. But there is no such cycle in  $I$  neither in  $I + r$ . Thus, there is no odd cycle in  $G$ .

Observe that  $\Delta(G) = t + 1$  and only the vertices in  $\{s, r, u_1, \dots, u_t\}$  have degree  $t + 1$ . Therefore all of them must be b-vertices. Observe moreover that  $\Gamma(G) = \Delta(G) + 1 = t + 2$ .

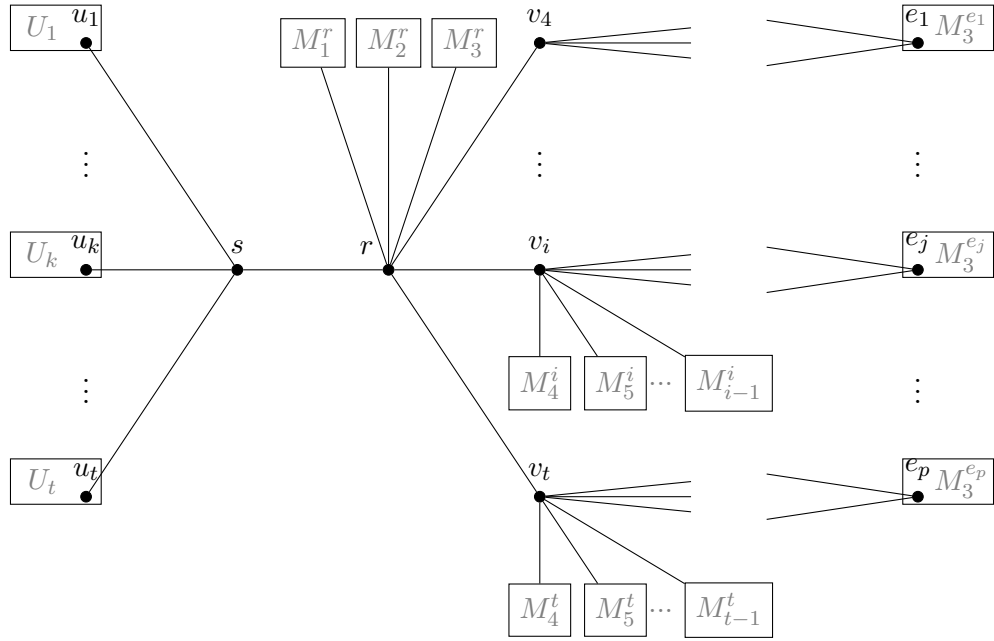

Figure 33 – The graph  $G$ .

Indeed, each  $U_i$  admits a greedy colouring such that  $u_i$  is coloured  $i + 1$ ; taking the union of these colourings, colouring  $s$  with  $t + 2$  and  $r$  with 1, and extending this colouring greedily, we obtain a greedy  $(t + 2)$ -colouring of  $G$ .

We shall now prove that  $H$  admits a proper 3-edge-colouring if and only if  $\Gamma_b(G) = \Delta(G) + 1$  (resp.  $z(G) = \Delta(G) + 1$ ).

Assume that  $H$  admits a proper 3-edge-colouring  $\Phi$ . We set  $c(e_i) = \Phi(e_i)$ , for every  $i \in [p]$ , and then we greedily colour the other vertices of  $M_3^{e_i}$ . So far, for  $i \in \{4, \dots, t\}$ ,  $v_i$  has one neighbour in  $I$  for each colour in  $[3]$ , then we set  $c(v_i) = i$  and for every  $4 \leq j \leq i - 1$  we greedily colour  $M_j^i$  in such way that  $c(v_j^i) = j$  and we do the same with  $M_1^r, M_2^r, M_3^r$  so that  $r$  has a neighbour of each colour in  $[3]$ . Finally we set  $c(r) = t + 1, c(s) = t + 2$  and we greedily colour  $U_k$  so that  $c(u_k) = k$ , for every  $k \in [t]$ . Note that, for  $k \in [t]$ ,  $u_k$  is a b-vertex of colour  $k$ ;  $r$  is a b-vertex of colour  $t + 1$ ;  $s$  is the b-vertex of colour  $t + 2$  and moreover it is adjacent to all the others b-vertices. Thus,  $c$  is a  $z$ -colouring (and also a b-greedy colouring).

Assume now that  $G$  admits a b-greedy-colouring  $c$  with  $\Delta(G) + 1$  colours. As only  $s, r, u_1, \dots, u_t$  have degree  $t + 1$ , those vertices must be b-vertices.

We first show that  $c(s) = t + 2$ . Assume for a contradiction that  $c(s) < t + 2$ . Then, for every  $i$  in  $[t]$ ,  $c(u_i) = t + 2$  because  $u_i$  is a b-vertex and all its neighbours in  $U_i$  have degree  $t$  and so their colours are at most  $t + 1$ . But, this contradicts the fact that  $s$  is a b-vertex. Thus

$c(s) = t + 2$ . This shows that every  $b$ -greedy colouring of  $G$  is also a  $z$ -colouring.

Now, we claim that  $c(r) \in \{t, t + 1\}$ . If  $c(r) \neq t + 1$ , then  $r$  must be adjacent to a vertex of colour  $t + 1$  and this vertex can only be  $v_t$  because  $c(s) = t + 2$  and the other neighbours of  $r$  have degree at most  $t - 1$ . This implies that  $v_t$  has a neighbour of colour  $t$  which must be  $r$  because the other candidate (in  $M_{t-1}^t$ ) has degree  $t - 1$  and it is already adjacent to a vertex of colour  $t + 1$ .

If  $c(r) = t$ , then we can obtain another  $b$ -greedy colouring  $c'$  with  $t + 2$  colours such that  $c'(r) = t + 1$  as follows. Let  $u_k$  be the neighbour of  $s$  which has colour  $t + 1$ . We set  $c'(u_k) = t$ ,  $c'(r) = t + 1$ ,  $c'(v_t) = t$ , then we greedily recolour the other vertices of  $U_k$ , and finally we set  $c'(w) = c(w)$ , for  $w \in V(G) - \{r, v_t\} \cup U_k$ .

Henceforth, free to replace  $c$  by  $c'$ , we may assume that  $c(r) = t + 1$ , we have that, for every  $i \in [t]$ ,  $r$  has a neighbour of colour  $i$  in  $\{v_1, v_2, \dots, v_t\}$ . Note that  $d(v_i) = i$  and therefore  $c(v_i) \leq i$  because  $v_i$  is adjacent to  $r$  and  $c(r) > d(v_i)$ , for all  $i \in [t]$ . This implies that  $v_t$  is the only vertex of  $\{v_1, v_2, \dots, v_t\}$  that can be coloured with the colour  $t$  and similarly  $v_{t-1}$  must have the colour  $t - 1$  and so on. Thus,  $c(v_i) = i$ , for every  $i \in [t]$ , and this induces a proper 3-edge-colouring of  $H$  because  $v_i$  has a distinct neighbour for every colour  $j$  in  $[i - 1]$  and in particular its neighbours of  $I$  have different colours. Furthermore, for every  $i \in [p]$ , since  $d_G(e_i) = 4$  and  $e_i$  already adjacent to two vertices of colour at least 4, necessarily  $c(e_i) \in \{1, 2, 3\}$ .

□

**Corollary 4.2.2.** *It is NP-complete to decide whether a given bipartite graph  $G$  such that  $\chi_b(G) = \Delta(G) + 1$  satisfies  $\Gamma_b(G) = \chi_b(G)$  (resp.  $z(G) = \chi_b(G)$ ).*

*Proof.* Let  $G$  be a bipartite graph. Set  $k = \Delta(G) + 1$ .

Let  $G' = G + kS_k$ . We clearly have  $\chi_b(G') = k = \Delta(G') + 1$  because  $\chi_b(kS_k) = k$ . Now as in Proposition 4.1.10, in every  $b$ -greedy colouring of  $G'$  the vertices of  $kS_k$  are coloured 1 or 2. Hence  $G'$  has a  $b$ -greedy  $k$ -colouring (resp.  $k$ - $z$ -colouring) if and only if  $G$  does.

Theorem 4.2.1 yields the result.

□

**Corollary 4.2.3.** *Given a graph  $G$  and two parameters  $\gamma_1 \in \{\omega, \chi\}$  and  $\gamma_2 \in \{z, \Gamma_b\}$ , the problem of deciding whether  $\gamma_1(G) = \gamma_2(G)$  is coNP-hard.*

*Proof.* We give a reduction from the problem of deciding whether a given bipartite graph  $G'$  satisfies  $\gamma_2(G') = \Delta(G') + 1$  which is NP-complete by Theorem 4.2.1.



Let  $G'$  be an instance of this problem and let  $G = G' + K_{\Delta(G')}$ . We claim that  $\gamma_2(G) \neq \gamma_1(G)$  if and only if  $\gamma_2(G') = \Delta(G') + 1$ .

Since  $G'$  is bipartite,  $\omega(G') \leq \chi(G') \leq 2$ , that is  $\gamma_1(G') \leq 2$ . Hence, we have that  $\gamma_1(G) = \gamma_1(K_{\Delta(G')}) = \Delta(G')$ . In addition,  $\gamma_2(G) \geq \Gamma_b(G) \geq \Delta(G')$  because the b-Grundy number of a graph at least as large as the b-Grundy of its connected components (Proposition 4.1.5) and  $\Gamma_b(K_{\Delta(G')}) = \Delta(G')$ .

Assume that there is a b-greedy colouring  $\phi$  of  $G$  with  $\Delta(G') + 1$  colours. Then all the  $b$ -vertices are in  $G'$  because  $\Delta(K_{\Delta(G')}) < \Delta(G')$ . Now the restriction of  $\phi$  to  $G'$  is a greedy colouring (because it is the restriction of a greedy colouring to one of its connected components) and a  $(\Delta(G') + 1)$ -b-colouring, and thus a b-greedy  $(\Delta(G') + 1)$ -colouring. On the other hand, a  $(\Delta(G') + 1)$ -z-colouring (b-greedy colouring) of  $G'$  plus any colouring of  $K_{\Delta(G')}$  is a z-colouring (b-greedy colouring) for  $G$ . Consequently,  $\gamma_2(G) = \Delta(G) + 1$  if and only if  $\gamma_2(G') = \Delta(G') + 1$ . Thus,  $\gamma_2(G) \neq \gamma_1(G) = \Delta(G')$  if and only if  $\gamma_2(G') = \Delta(G') + 1$ .  $\square$

**Remark 4.2.4.** *Corollary 4.2.3 implies that deciding whether  $\chi(G) = \Gamma_b(G)$  (resp.  $\chi(G) = z(G)$ ) is coNP-complete. Indeed a proper colouring with  $\gamma$  colours and a b-greedy colouring (resp. z-colouring) with  $\gamma'$  colours such that  $\gamma' > \gamma$  form a certificate that  $\chi(G) < \Gamma_b(G)$  (resp.  $\chi(G) < z(G)$ ).*

**Corollary 4.2.5.** *Is NP-hard to decide whether  $z(G) = \Gamma_b(G)$ .*

*Proof.* Let  $D_d$  be the disjoint union of a complete graph  $K_d^1$  with vertex set  $\{v_1^1, \dots, v_d^1\}$  and three complete graphs  $K_{d-1}^i$ ,  $i = 2, 3, 4$  with vertex set  $\{v_1^i, \dots, v_{d-1}^i\}$ . Let  $L_d$  be the graph obtained from  $D_d$  by removing the edge  $v_1^1 v_2^1$  and adding a new vertex  $v_0$  along with the edges  $v_0 v_2^1, v_{d-1}^2 v_1^3, v_{d-1}^3 v_{d-1}^4$ . See Figure 34 for an example.

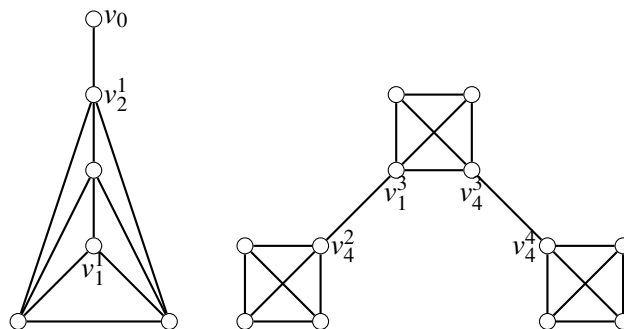

Figure 34 – The graph  $L_5$ .

**Claim 4.2.5.1.**  $\Gamma_b(L_d) = d$  and  $z(L_d) \leq d - 1$ .

*Proof.* Since  $\Delta(L_d) = d - 1$ , we have  $z(L_d) \leq \Gamma_b(L_d) \leq d$ .

Consider the following colouring  $\phi$  of  $L_d$ :  $\phi(v_0) = 1$ ,  $\phi(v_i^1) = i$ , for  $i \in [d]$  and, for  $j \in [d - 1], k \in \{2, 3, 4\}$ ,  $\phi(v_j^k) = \begin{cases} d, & \text{if } j = d - 1 \text{ and } k = 3 \\ j, & \text{otherwise.} \end{cases}$

Observe that  $v_1^1$  is a b-vertex of colour  $i$  for every  $i \in \{2, 3, \dots, d\}$  and, since  $v_1^1$  and  $v_0$  are greedy, all the vertices in  $V(K_d^1)$  are greedy. For  $j \in [d - 1]$  and  $k \in \{2, 3, 4\}$ ,  $v_j^k$  is also a greedy vertex. Furthermore,  $v_1^3$  is a b-vertex of colour 1 because it is adjacent to  $v_i^3$  which has colour  $i$ , for  $i \in \{2, 3, \dots, d - 2\}$ , and it is also adjacent to  $v_{d-1}^2$  and  $v_{d-1}^3$ , which have colours  $d - 1$  and  $d$  respectively.

Set  $V_L = V(K_d^1) \cup \{v_0\}$  and  $V_R = V(K_{d-1}^2) \cup V(K_{d-1}^3) \cup V(K_{d-1}^4)$  be the vertex sets of the two connect components of  $L_d$ . Recall that  $m_z(G)$  is the largest integer  $k$  such that there is a vertex of  $G$  which has  $k$  neighbours of degree at least  $k$ . Observe that if  $v_i^1$ , for  $i \in \{2, 3, \dots, d\}$ , is a vertex of degree  $d - 1$  in the component induced by  $V_L$  either  $v_i^1$  is neighbour of  $v_1^1$  or  $v_0$  which have degree  $d - 2$  and 1 respectively. Then,  $m_z(L_d[V_L])$  is at most  $d - 2$ , and it is equals to  $d - 2$  because  $L_d[\{v_2^1, v_3^1, \dots, v_d^1\}]$  is a clique of size  $d - 1$ . On the other side, in the component induced by  $V_R$ , only the vertices  $v_{d-1}^2, v_1^3, v_{d-1}^3, v_{d-1}^4$  have degree  $d - 1$  while the remaining vertices have degree  $d - 2$ . Thus, we have that  $m_z(L_d) = d - 2$  and therefore, by Lemma 4.1.12,  $z(L_d) \leq d - 1$ .

◇

We now give a reduction from the problem of deciding whether  $z(G) = \Delta(G) + 1$  for a given graph  $G$ , which is NP-complete by Theorem 4.2.1. Let  $G$  be the graph and let  $G'$  be the disjoint union of  $G$  and  $L_{\Delta(G)+1}$ . Since  $\Delta(G') = \Delta(G)$ , we have that  $\Gamma_b(G') \leq \Delta(G) + 1$ . By Claim 4.2.5.1 and Proposition 4.1.5 (ii), we have  $\Gamma_b(G') \geq \Delta(G) + 1$  and therefore  $\Gamma_b(G') = \Delta(G) + 1$ . By Claim 4.2.5.1,  $z(L_{\Delta(G)+1}) \leq \Delta(G)$ . Thus, by Proposition 4.1.5 (i),  $z(G') = \Delta(G) + 1 = \Gamma_b(G')$ , if and only if  $z(G) = \Delta(G) + 1$ . □

### 4.3 Atoms and polynomial-time algorithms

Zaker (ZAKER, 2006) showed that for every positive integer  $j$  there exists a finite set  $\mathcal{A}_j^\Gamma$  of graphs, called  **$j$ -greedy atoms**, such that for any graph  $G$  the following holds:  $\Gamma(G) \geq j$  if and only if  $G$  contains a  $j$ -greedy atom. Moreover, he showed that every element of  $\mathcal{A}_j^\Gamma$  has at

most  $2^{j-1}$  vertices. The following lemma follows directly from this fact and is implicitly used in many papers.

**Lemma 4.3.1.** *Let  $G$  be a graph,  $\phi$  a greedy colouring of  $G$ , and  $v$  a vertex of  $G$ . Then  $G$  contains an induced subgraph  $H$  containing  $v$  which is a  $\phi(v)$ -greedy atom and such that  $\phi$  is a greedy  $\phi(v)$ -colouring of  $H$ .*

The following is also implicit in Section 3 of Zaker (ZAKER, 2020).

**Lemma 4.3.2.** *Let  $G$  be a graph. If  $\phi$  is a  $k$ -z-colouring of  $G$ , then there is an induced subgraph  $H$  of order at most  $(k-3)2^{k-1} + k + 2$  such that  $\phi$  is a  $k$ -z-colouring of  $H$ .*

We now prove the analogue for b-greedy colouring.

**Lemma 4.3.3.** *Let  $G$  be a graph. If  $\phi$  is a b-greedy  $k$ -colouring of  $G$ , then there is an induced subgraph  $H$  of order at most  $(k-1)2^k + k + 1$  such that  $\phi$  is a b-greedy  $k$ -colouring of  $H$ .*

*Proof.* Let  $\phi$  be a b-greedy colouring of  $G$ . For  $i \in [k]$ , let  $b_i$  be the  $b$ -vertex of  $G$  coloured  $i$ . For each  $i \in [n]$ , and  $j \in [k] \setminus \{i\}$ , let  $c_i^j$  be the neighbour of  $b_i$  coloured  $j$ . By Lemma 4.3.1, there is an induced subgraph  $H_i^j$  containing  $c_i^j$  which is a  $j$ -greedy atom and such that  $\phi$  is a  $j$ -greedy colouring of  $H_i^j$ . Let  $H$  be the subgraph of  $G$  induced by  $\bigcup_{i \in [k]} \left( \{b_i\} \cup \bigcup_{j \in [k] \setminus \{i\}} V(H_i^j) \right)$ . Clearly,  $\phi$  is a greedy colouring of  $H$  in which each  $b_i$  is a  $b$ -vertex. Therefore  $\phi$  is a b-greedy colouring of  $H$ . Now every  $j$ -greedy atom has size at most  $2^{j-1}$ , thus  $|\bigcup_{j \in [k] \setminus \{i\}} V(H_i^j)| \leq 2^k - 2^{i-1}$ . Hence  $|H| \leq (k-1)2^k + k + 1$ .  $\square$

A  **$k$ -z-atom** is a graph  $G$  having a  $k$ -z-colouring  $\phi$  that is not a  $k$ -z-colouring of any proper subgraph  $H$  of  $G$ . The z-atoms were introduced by Zaker in (ZAKER, 2020). But we can also extend this notion to b-greedy colourings. A **b-greedy  $k$ -atom** is a graph  $G$  having a b-greedy  $k$ -colouring  $\phi$  that is not a b-greedy  $k$ -colouring of any proper subgraph  $H$  of  $G$ .

Lemma 4.3.2 and Lemma 4.3.3 imply that, for any fixed  $k$ , the number of  $k$ -z-atoms and the number of b-greedy  $k$ -atoms is finite. By definition, a graph with z-number  $k$  (resp. b-Grundy number  $k$ ) contains a  $k$ -z-atom (resp. b-greedy  $k$ -atom). But, in contrast to the Grundy number, the converse is not true because the  $k$ -z-colouring (resp. b-greedy  $k$ -colouring) of an induced subgraph cannot always be extended into a  $k$ -z-colouring (resp. b-greedy  $k$ -colouring) of the whole graph. Nevertheless, this is true for some graph classes such as trees as shown by Lemma 4.5.1.

#### 4.4 b-greedy and z-colourings in regular graphs

Recall that a graph is  $d$ -**regular** if each of its vertices has degree  $d$ . It has been proved that a  $d$ -regular graph with sufficiently high order  $n$  has b-chromatic number  $d + 1$  ( $n \geq d^4$  (KRATOCHVÍL *et al.*, 2002),  $n \geq 2d^3$  (CABELLO; JAKOVAC, 2011),  $n \geq 2d^3 - 2d^2 + 2d$  (AMINE *et al.*, 2015)). For **cubic** (i.e. 3-regular) graphs, Jakovac and Klavžar (JAKOVAC; KLAVŽAR, 2010) proved a more precise result: all cubic graphs have b-chromatic number 4 except four exceptions: the complete bipartite graph  $K_{3,3}$ , the prism  $K_3 \square K_2$ , the Petersen graph  $P_{10}$ , and another graph  $G_{10}$  on ten vertices. See Figure 35.

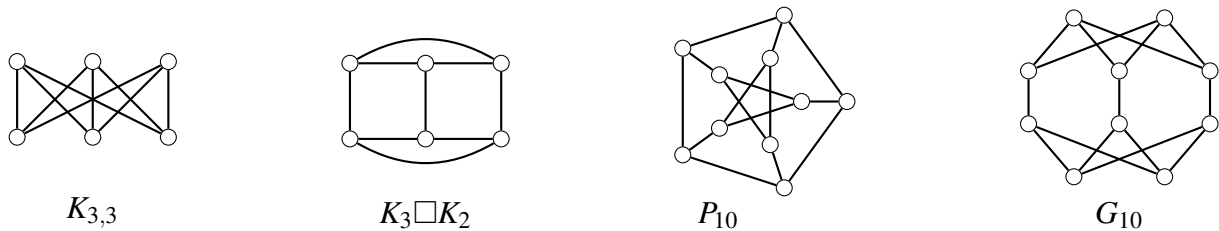

Figure 35 – The four cubic graphs with b-chromatic number less than 4.

For any integer  $d \geq 2$ , Gastineau *et al.* (GASTINEAU *et al.*, 2014) showed an infinite family of  $d$ -regular graphs with Grundy number at most  $d$ , and made the following conjecture, which they proved for  $d = 3$ . It is easy for  $d = 2$  (see the proof of Theorem 4.4.3).

**Conjecture 4.4.1** (Gastineau *et al.* (GASTINEAU *et al.*, 2014)). *For any positive integer  $d$ , every  $d$ -regular graph with no induced 4-cycle has Grundy number  $d + 1$ .*

As an extension of these results and conjecture, we conjecture the following.

**Conjecture 4.4.2.** *For any positive integer  $d$ , all  $d$ -regular graphs with no induced 4-cycle have z-number  $d + 1$  except a finite number of exceptions.*

The case where  $d = 2$  is quite simple as we can see in the following theorem.

**Theorem 4.4.3.** *Let  $G$  be a 2-regular graph. If  $G$  has no induced 4-cycle, then  $z(G) = 3$ .*

*Proof.* Since every 2-regular graph is formed by disjoint cycles, by Proposition 4.1.5 (i)  $z(G)$  will be equal to the maximum z-number of these cycles. Given that  $G$  is free of  $C_4$  and  $z(C_3) = 3$ , it suffices to show that every cycle with at least 5 vertices have z-number 3. Let  $v_1, v_2, v_3, v_4, v_5$

be five consecutive vertices in a cycle with at least 5 vertices. If we colour these vertices with the colours 2,1,3,2,1, respectively, we have a 3-z-colouring for the graph induced by them. We can complete the colouring to the whole cycle by going around from  $v_5$  to  $v_1$  alternating the colours 1 and 2 if the cycle is odd, otherwise we can do the same but colouring the vertex before  $v_1$  with colour 3. In both situations we have a 3-z-colouring and the result follows.  $\square$

As the main result of this section, we prove this conjecture for  $d = 3$  by showing the following.

**Theorem 4.4.4.** *Let  $G$  be a cubic graph with no induced  $C_4$ . If  $G$  is not the Petersen graph, then  $z(G) = \Gamma_b(G) = 4$ .*

To prove Theorem 4.4.4, we divide the proof into three cases. The first one considers cubic graphs of girth at least 6 (Theorem 4.4.6), the second one cubic graphs of girth exactly 5 (Theorem 4.4.7), and the third one cubic graphs of girth 3 (Theorem 4.4.8).

We need the following lemma.

**Lemma 4.4.5.** *Let  $G$  be a cubic graph of girth at least 5, and  $x$  and  $y$  be two vertices of  $G$ . There are two vertices distinct from  $y$  which are adjacent to  $x$  and non-adjacent to  $y$ .*

*Proof.* If  $x$  is adjacent to  $y$ , let  $w_1$  and  $w_2$  be the neighbours of  $x$  distinct from  $y$ . They are non-adjacent to  $y$  for otherwise, there would be a 3-cycle, so they are the desired vertices.

If  $x$  and  $y$  are non-adjacent, then  $x$  and  $y$  have at most one neighbour in common, for otherwise there is a 4-cycle. Hence at least two neighbours of  $x$  are non-adjacent to  $y$ .  $\square$

**Theorem 4.4.6.** *If  $G$  is a cubic graph of girth at least 6, then  $z(G) = \Gamma_b(G) = 4$ .*

*Proof.* Let  $G$  be a cubic graph. We have  $z(G) \leq \Gamma_b(G) \leq 4$ .

Assume that  $G$  has girth at least 6. We shall prove that  $z(G) \geq 4$ . To do so, thanks to Lemma 4.4.10, it suffices to exhibit an induced subgraph of  $G$  and 4-z-colouring of it.

We distinguish five cases depending on the existence of 6-cycles and how they intersect.

Case 1 : Assume first that  $G$  contains the graph  $I_1$  depicted in Figure 36 as a (necessarily induced) subgraph.

For  $i \in [3]$ , let  $c'_i$  be the neighbour of  $b_i$  not in  $V(I_1)$ , and let  $d_i$  be the neighbour of  $c_i$  not in  $V(I_1)$ .

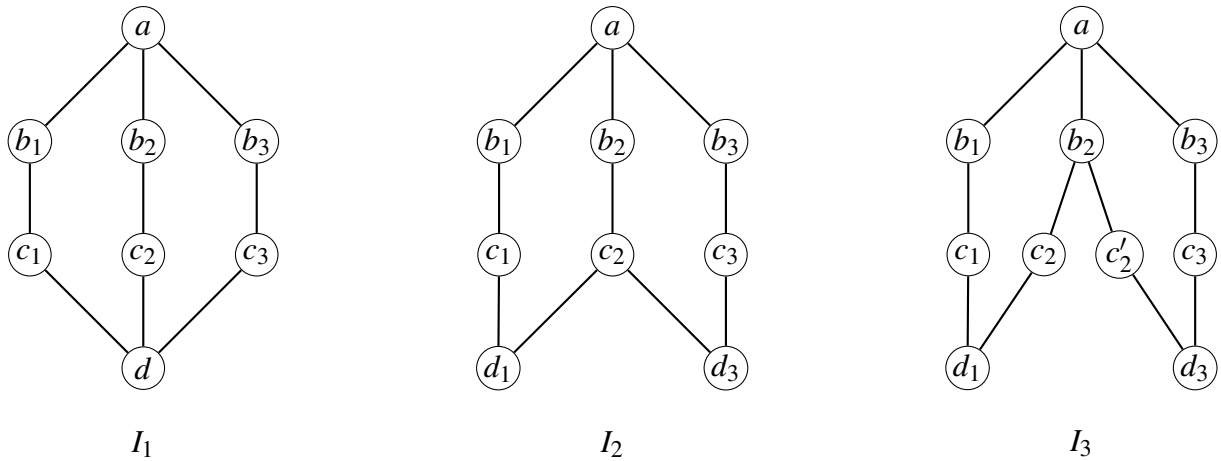

Figure 36 – The graphs  $I_1, I_2,$  and  $I_3$  made of two intersecting 6-cycles.

Suppose first that  $d_1$  has a neighbour  $e_1$  distinct from  $c_1$  which is non-adjacent to both  $c'_2$  and  $c'_3$ . Note that among the above-mentioned vertices  $e_1$  can only be adjacent to  $b_3$  and  $b_2$ . Therefore the subgraph induced by  $V(I_1) \cup \{c'_1, c'_2, c'_3, d_1, e_1\}$  is the configuration  $J_1$  depicted in Figure 37. Set  $\phi(a) = 4, \phi(b_3) = \phi(c_1) = \phi(c_2) = 3, \phi(b_2) = \phi(c'_1) = \phi(c_3) = \phi(d_1) = 2, \phi(b_1) = \phi(c'_2) = \phi(c'_3) = \phi(d) = \phi(e_1) = 1$ . See Figure 37. Observe that for each  $i \in [3], \phi^{-1}(i)$  is a stable set of  $G$  for otherwise there would be a cycle of length at most 5. Hence  $\phi$  is a 4-z-colouring of  $J_1$ .

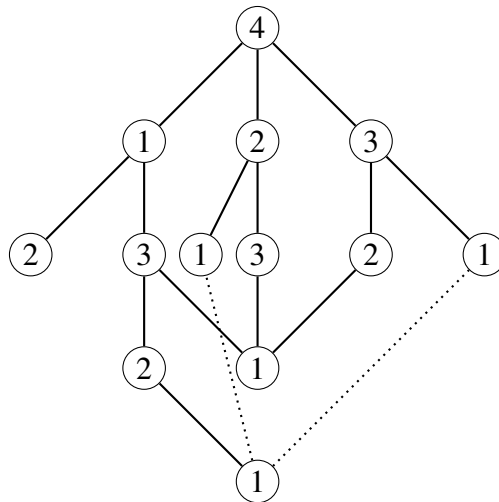

Figure 37 – The configuration  $J_1$  and its 4-z-colouring. Dotted lines represent non-edges. Some edges may be missing.

Henceforth we may assume that the two neighbours of  $d_1$  distinct from  $c_1$  are adjacent to either  $c'_2$  or  $c'_3$ . Since there is no 4-cycle, then one of them, say  $d'_2$ , is adjacent to  $c'_2$  and the other, say  $d'_3$ , is adjacent to  $c'_3$ . By symmetry, interchanging the indices 3 and 1, we get that  $d_3$  has a neighbour  $d'_1$  adjacent to  $c'_1$  and not  $c'_2$ . Applying the same reasoning interchanging

the role of  $d, c_1, c_2, c_3$  with  $a, b_3, b_2, b_1$  respectively, either we find a 4-z-colouring of  $G$ , or  $d_2$  and  $c'_3$  have a common neighbour, say  $e_2$ . Now since  $G$  has girth 6, the vertices  $d_2, d'_2, c'_1$  and  $d'_3$  are distinct. Hence since  $G$  is cubic, the vertex  $d'_1$  is non-adjacent to at least one vertex in  $\{d_2, d'_2\}$ .

If  $d'_1$  is non-adjacent to  $d'_2$ , then we are in the configuration  $J'_1$  depicted in Figure 38. Set  $\phi(a) = 4, \phi(b_2) = \phi(c'_1) = \phi(c_3) = 3, \phi(b_1) = \phi(c'_2) = \phi(c'_3) = \phi(d) = 2, \phi(b_3) = \phi(c_1) = \phi(c_2) = \phi(d'_1) = \phi(d'_2) = 1$ . Observe that for each  $i \in [3], \phi^{-1}(i)$  is a stable set of  $G$  for otherwise there would be a cycle of length at most 5. Hence  $\phi$  is a 4-z-colouring of an induced subgraph of  $G$ .

If  $d'_1$  is non-adjacent to  $d_2$ , then we are in the configuration  $J''_1$  depicted in Figure 38. Set  $\phi(a) = 4, \phi(b_1) = \phi(c_2) = \phi(c_3) = 3, \phi(b_2) = \phi(c'_1) = \phi(c'_3) = \phi(d) = 2$ , and  $\phi(b_3) = \phi(c_1) = \phi(c'_2) = \phi(d_2) = \phi(d'_1) = 1$ . For each  $i \in [3], \phi^{-1}(i)$  is a stable set of  $G$  for otherwise there would be a cycle of length at most 5. Hence  $\phi$  is a 4-z-colouring of an induced subgraph of  $G$ .

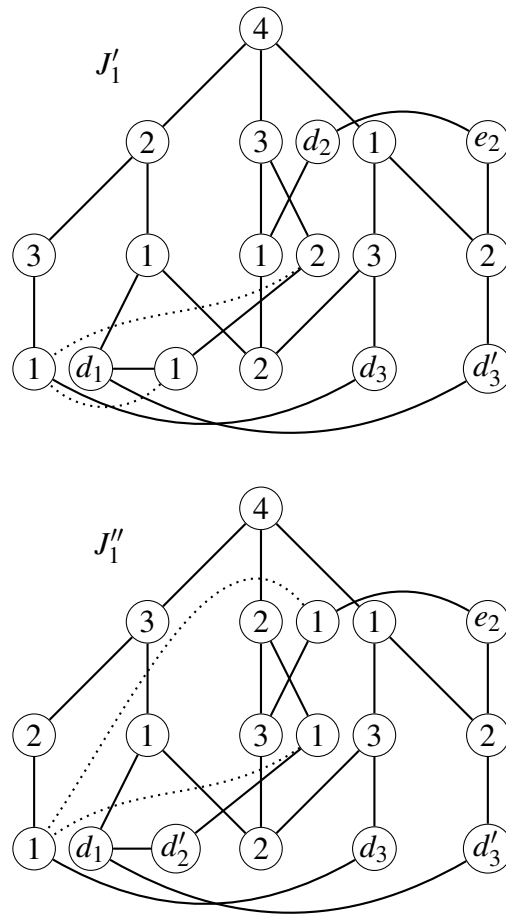

Figure 38 – The configurations  $J'_1$  and  $J''_1$  and their partial 4-z-colourings. Dotted lines represent non-edges. Some edges may be missing.

This complete the proof of Case 1.

Case 2 : Assume that  $G$  contains the graph  $I_2$  depicted in Figure 36 as a (necessarily induced) subgraph.

For  $i \in [3]$ , let  $c'_i$  be the neighbour of  $b_i$  not in  $V(I_2)$ . By Lemma 4.4.5,  $c'_1$  has two neighbours which are not adjacent to  $d_3$ , so there is a vertex  $d'_1$  distinct from  $b_1$  which is adjacent to  $c'_1$  and not adjacent to  $d_3$ . We may assume that  $d'_1$  is not adjacent to  $c'_3$  for otherwise  $G$  contains  $I_1$  and we are in Case 1. Hence, the subgraph induced by  $V(I_2) \cup \{c'_1, c'_2, c'_3, d'_1\}$  is a configuration  $J_2$  depicted in Figure 39. Set  $\phi(a) = 4$ ,  $\phi(b_1) = \phi(c_2) = \phi(c_3) = 3$ ,  $\phi(b_3) = \phi(c'_1) = \phi(c'_2) = \phi(d_1) = 2$ ,  $\phi(b_2) = \phi(c_1) = \phi(c'_3) = \phi(d'_1) = \phi(d_3) = 1$ . Observe that for each  $i \in [3]$ ,  $\phi^{-1}(i)$  is a stable set of  $G$  for otherwise there would be a cycle of length at most 5. Hence  $\phi$  is a 4-z-colouring of  $J_2$ .

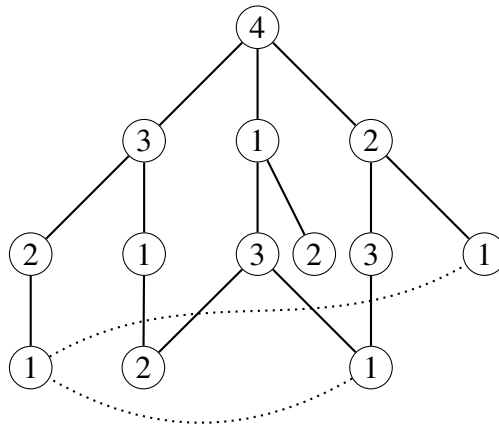

Figure 39 – The configuration  $J_2$  and its 4-z-colouring. Dotted lines represent non-edges. Some edges may be missing.

This complete the proof of Case 2.

Case 3 : Assume that  $G$  contains the graph  $I_3$  depicted in Figure 36 as a subgraph. We may assume that  $c_1d_3$  and  $c_3d_1$  are not edges for otherwise  $G$  contains  $I_1$  and we are in Case 1. Let  $c'_1$  be the neighbour of  $b_1$  distinct from  $a$  and  $c_1$ , and  $c'_3$  be the neighbour of  $b_3$  distinct from  $a$  and  $c_3$ . The subgraph induced by  $V(I_3) \cup \{c'_1, c'_3\}$  is a configuration  $J_3$  as depicted on Figure 40. Set  $\phi(a) = 4$ ,  $\phi(b_3) = \phi(c_1) = \phi(c'_2) = 3$ ,  $\phi(b_2) = \phi(c'_1) = \phi(c_3) = \phi(d_1) = 2$ ,  $\phi(b_1) = \phi(c_2) = \phi(c'_3) = \phi(d_3) = 1$ . Observe that for each  $i \in [3]$ ,  $\phi^{-1}(i)$  is a stable set of  $G$  for otherwise there would be a cycle of length at most 5. Hence  $\phi$  is a 4-z-colouring of  $J_3$ .

This complete the proof of Case 3.



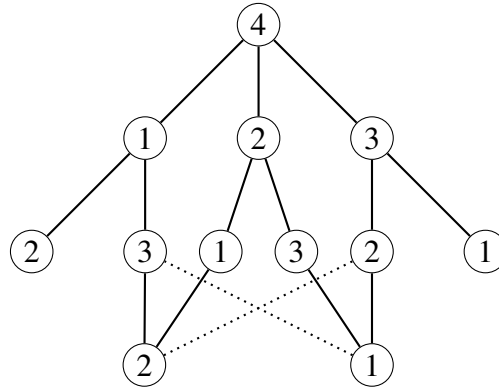

Figure 40 – The configuration  $J_3$  and its 4-z-colouring. Dotted lines represent non-edges. Some edges may be missing.

Case 4 :  $G$  contains a 6-cycle that intersects no other 6-cycle. Let  $C = (a, b_1, c_1, d, c_2, b_2, a)$  be a 6-cycle that intersects no other 6-cycles. Let  $b_3$  be the neighbour of  $a$  not in  $V(C)$ . Let  $c'_1$  (resp.  $c'_2$ ) be the neighbour of  $b_1$  (resp.  $b_2$ ) not in  $V(C)$ , and let  $c_3$  and  $c'_3$  be the two neighbours of  $b_3$  distinct from  $a$ . Let  $d'_2$  be a neighbour of  $c'_2$  distinct from  $b_2$ . By Lemma 4.4.5,  $c'_3$  has a neighbour  $d'_3$  distinct from  $b_3$  which is not adjacent to  $d'_2$ . Observe that  $d'_2$  and  $c_3$  are not adjacent for otherwise  $(a, b_2, c'_2, d'_2, c_3, b_3, a)$  would be a 6-cycle intersecting  $C$  (and we would be in Case 3). Similarly,  $d$  and  $c'_3$  are not adjacent for otherwise  $(a, b_2, c_2, d, c'_3, b_3, a)$  would be a 6-cycle intersecting  $C$  (and we would be in Case 1). Therefore the subgraph induced by  $V(C) \cup \{b_3, c'_1, c'_2, c_3, c'_3, d'_2, d'_3\}$  is the configuration  $J_4$  depicted on Figure 41. Set  $\phi(a) = 4$ ,  $\phi(b_3) = \phi(c_1) = \phi(c'_2) = 3$ ,  $\phi(b_2) = \phi(c'_1) = \phi(c'_3) = \phi(d) = 2$ ,  $\phi(b_1) = \phi(c_2) = \phi(c_3) = \phi(d'_2) = \phi(d'_3) = 1$ . Observe that for each  $i \in [3]$ ,  $\phi^{-1}(i)$  is a stable set of  $G$  for otherwise there would be a cycle of length at most 5. Hence  $\phi$  is a 4-z-colouring of  $J_4$ .

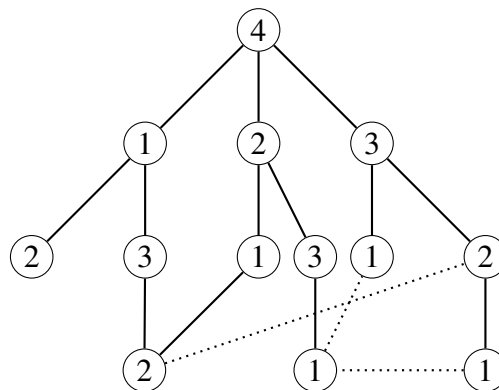

Figure 41 – The configuration  $J_4$  and its 4-z-colouring. Dotted lines represent non-edges. Some edges may be missing.

This completes Case 4.

Case 5 :  $G$  has girth at least 7.

Let  $b_4$  be a vertex of  $G$ , and let  $b_1, b_2, b_3$  be its three neighbours. Let  $c_2, c_3$  the neighbours of  $b_1$  distinct from  $b_4$ ,  $c_1, c'_3$  be the neighbours of  $b_2$  distinct from  $b_4$ , and  $c'_1, c'_2$  be the neighbours of  $b_1$  distinct from  $b_4$ . The subgraph  $T$  induced by those ten vertices is a tree for otherwise there would be a cycle of length at most 5. Observe that no vertex of  $G - T$  is adjacent to more than one vertex of  $T$  for otherwise, there would be a cycle of length at most 6. Let  $d_2$  be a neighbour of  $c_3$  distinct from  $b_1$ . Among the two neighbours of  $c'_3$  distinct from  $b_1$ , at least one of them, say  $d'_2$  is not adjacent to  $d_2$  for otherwise there would be a 4-cycle. Similarly, let  $d_1$  be a neighbour of  $c_2$  distinct from  $b_1$ . Among the two neighbours of  $c'_2$  distinct from  $b_3$ , at least one of them, say  $d'_1$  is not adjacent to  $d_1$  for otherwise there would be a 4-cycle. By the above observation  $d_1, d'_1, d_2, d'_2$  are all distinct. Now let  $e_1$  be a neighbour of  $d_2$  distinct from  $c_3$ . Among the two neighbours of  $d'_2$  distinct from  $c'_3$ , at least one of them, say  $d'_1$  is not adjacent to  $d_1$  for otherwise there would be a 4-cycle. (Note that  $e_1$  and  $e'_1$  might be equal or in  $\{d_1, d'_1\}$ .) Let  $H$  be the subgraph induced by all the above named vertices. Now colour each vertex of  $H$  by its index (for example each  $b_i$  is coloured  $i$ ). One can easily check that this results in a 4-z-colouring of  $H$ , which can be greedily extended into a 4-z-colouring of  $G$ .

This completes Case 5 and the proof.  $\square$

**Theorem 4.4.7.** *Let  $G$  be a cubic graph of girth exactly 5. If  $G$  is not the Petersen graph, then  $z(G) = 4$ .*

*Proof.* To do so, thanks to Lemma 4.4.10, it suffices to exhibit an induced subgraph of  $G$  and 4-z-colouring of it, and we will do it (except in the case when  $G$  is the Petersen graph).

We distinguish several cases.

Case 1 : Assume first that  $G$  contains the graph  $I_5$  depicted in Figure 42 as a (necessarily induced) subgraph. For  $i \in [3]$ , let  $c'_i$  be the neighbour of  $b_i$  not in  $I_5$ .

Subcase 1.1 :  $c'_1$  and  $c_3$  are non-adjacent. Assume first that  $c'_1$  has a neighbour  $d'_1$  distinct from  $b_1$  and not adjacent to  $c'_2$  and  $b_3$ . Then we are in Configuration  $J_5^1$  depicted in Figure 43. Set  $\phi(a) = 4$ ,  $\phi(b_2) = \phi(c'_1) = \phi(c_3) = 3$ ,  $\phi(b_1) = \phi(c_2) = \phi(c'_3) = 2$ , and  $\phi(b_3) = \phi(c_1) = \phi(c'_2) = \phi(d'_1) = 1$ . For each  $i \in [3]$ ,  $\phi^{-1}(i)$  is a stable set of  $G$  for otherwise there would be a cycle of length at most 4 or a vertex would have degree more than 3. Hence  $\phi$  is a 4-z-colouring of  $J_5^1$ .

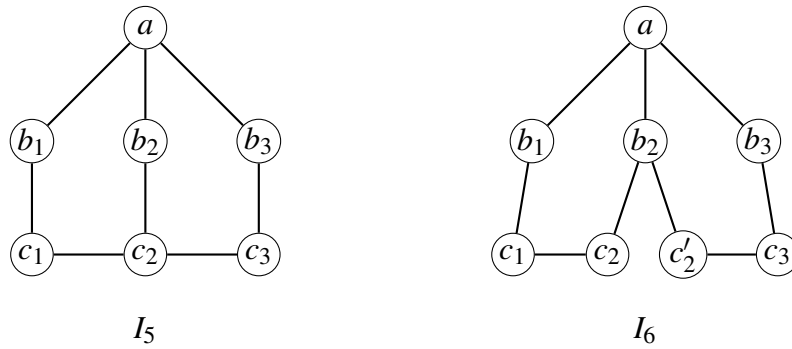

Figure 42 – The graphs  $I_5$  and  $I_6$  made of two intersecting 5-cycles.

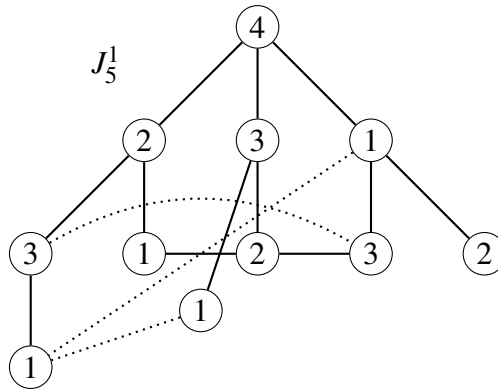

Figure 43 – The configuration  $J_5^1$  and its 4-z-colouring. Dotted lines represent non-edges. Some edges may be missing.

Henceforth, the two neighbours of  $c'_1$  distinct from  $b_1$  are either adjacent to  $c'_2$  or to  $b_3$ . Since there are no 4-cycle, one of them, say  $d'_1$ , is adjacent to  $c'_2$ , and the other is adjacent to  $b_3$  and must be  $c'_3$ . Let  $d_1$  be the neighbour of  $c_1$  not in  $I_5$ .

If  $d_1 \neq c'_3$ , then we are in Configuration  $J_5^2$  depicted in Figure 44. Set  $\phi(a) = 4$ ,  $\phi(b_3) = \phi(c_1) = \phi(c'_2) = 3$ ,  $\phi(b_1) = \phi(c_2) = \phi(c'_3) = \phi(d'_1) = 2$ , and  $\phi(b_2) = \phi(c'_1) = \phi(c_3) = \phi(d_1) = 1$ . For each  $i \in [3]$ ,  $\phi^{-1}(i)$  is a stable set of  $G$  for otherwise there would be a cycle of length at most 4. Hence  $\phi$  is a 4-z-colouring of  $J_5^2$ .

Henceforth, we may assume  $d_1 = c'_3$ . If  $d'_1$  and  $c_3$  are not adjacent, then we are in Configuration  $J_5^3$  depicted in Figure 45. Set  $\phi(c'_3) = 4$ ,  $\phi(b_1) = \phi(b_3) = 3$ ,  $\phi(b_2) = \phi(c_1) = \phi(c_3) = \phi(d'_1) = 2$ , and  $\phi(a) = \phi(c'_1) = \phi(c_2) = \phi(c'_2) = 1$ . For each  $i \in [3]$ ,  $\phi^{-1}(i)$  is a stable set of  $G$  for otherwise there would be a cycle of length at most 4. Hence  $\phi$  is a 4-z-colouring of  $J_5^3$ .

This completes Subcase 1.1.

Subcase 1.2 :  $c_1$  and  $c'_3$  are not adjacent. This subcase is symmetrical to Subcase 1.1.

Subcase 1.3 :  $c'_1$  and  $c_3$  are adjacent and  $c_1$  and  $c'_3$  are adjacent.

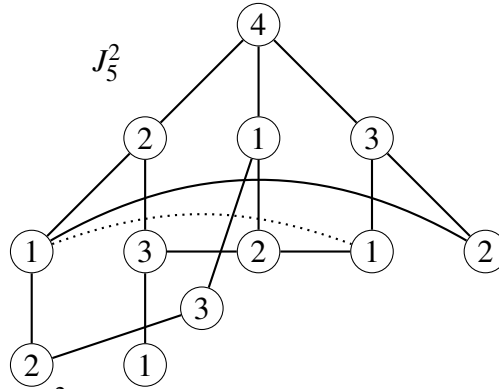

Figure 44 – The configuration  $J_5^2$  and its 4-z-colouring. Dotted lines represent non-edges. Some edges may be missing.

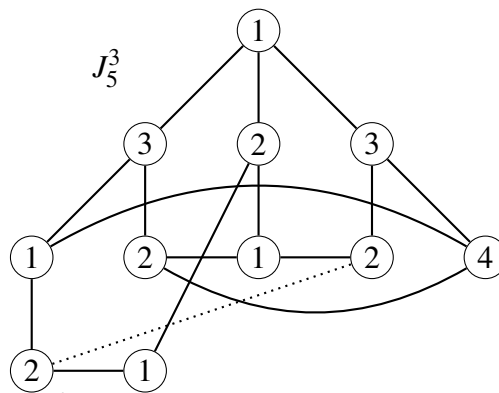

Figure 45 – The configuration  $J_5^3$  and its 4-z-colouring. Dotted lines represent non-edges.

If  $c'_2$  is adjacent to  $c'_1$  and  $c'_3$ , then  $G$  is the Petersen graph, whose b-chromatic number is 3 (JAKOVAC; KLAUVŽAR, 2010), so  $z(G) \leq 3$ . Henceforth, we may assume that  $c'_2$  is not adjacent to both  $c'_1$  and  $c'_3$ . By symmetry, we may assume that  $c'_1$  and  $c'_2$  are not adjacent.

By Lemma 4.4.5, there is a vertex  $d'_2$  distinct from  $b_2$  which is adjacent to  $c'_2$  and non-adjacent to  $c'_1$ . Thus we are in Configuration  $J_5^4$  depicted in Figure 46. Set  $\phi(a) = 4$ ,  $\phi(b_3) = \phi(c'_1) = \phi(c'_2) = 3$ ,  $\phi(b_2) = \phi(c_1) = \phi(c_3) = 2$ , and  $\phi(b_1) = \phi(c_2) = \phi(c'_3) = \phi(d'_2) = 1$ . For each  $i \in [3]$ ,  $\phi^{-1}(i)$  is a stable set of  $G$  for otherwise there would be vertices of degree more than 3. Hence  $\phi$  is a 4-z-colouring of  $J_5^4$ .

This completes Subcase 1.3. and Case 1.

Case 2 : Assume that  $G$  contains the graph  $I_6$  depicted in Figure 42 as a subgraph. If  $c_1$  and  $c_3$  are adjacent, then  $I_6 - c_2$  is isomorphic to  $I_5$  and we have the result by Case 1. Henceforth, we may assume that  $c_1$  and  $c_3$  are not adjacent, that is,  $I_6$  is an induced subgraph of  $G$ . Let  $c'_1$  (resp.  $c'_3$ ) be the neighbour of  $b_1$  (resp.  $b_3$ ) not in  $I_6$ . For all  $i \in [3]$ , let  $d_i$  be the neighbour of  $c_i$  not in  $I_6$  and let  $d'_i$  be the neighbour of  $c'_i$  not in  $I_6$ . If  $c'_1$  is adjacent to  $c'_2$  or  $c_3$ , then  $G$  contains  $I_5$  and we have the result by Case 1. Therefore we may assume that  $c'_1 c'_2$  and  $c'_1 c_3$  are non-edges.

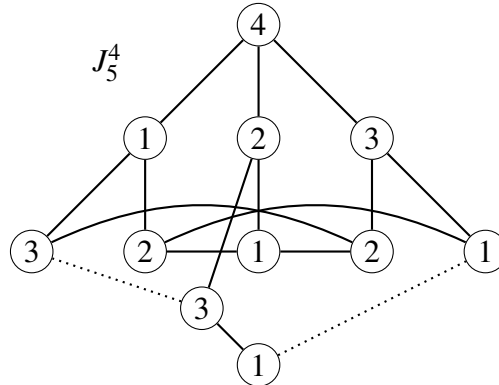

Figure 46 – The configuration  $J_5^4$  and its partial 4-z-colouring. Dotted lines represent non-edges. Some edges may be missing.

Symmetrically, we may assume that  $c'_3c_2$  and  $c'_3c_1$  are non-edges.

If  $d_2$  is not adjacent to  $c'_3$ , then we are in Configuration  $J_6^1$  depicted in Figure 47. Set  $\phi(a) = 4$ ,  $\phi(b_2) = \phi(c_2) = \phi(c_3) = 3$ ,  $\phi(b_3) = \phi(c_1) = \phi(c'_2) = 2$ , and  $\phi(b_1) = \phi(c'_2) = \phi(c'_3) = \phi(d_2) = 1$ . For each  $i \in [3]$ ,  $\phi^{-1}(i)$  is a stable set of  $G$  for otherwise there would be a cycle of length less than 5. Hence  $\phi$  is a 4-z-colouring of  $J_6^1$ .

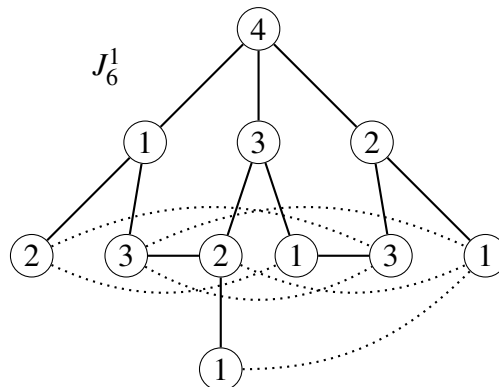

Figure 47 – The configuration  $J_6^1$  and its partial 4-z-colouring. Dotted lines represent non-edges. Some edges may be missing.

Henceforth, we may assume that  $d_2c'_3$  is an edge. By symmetry, we may also assume that  $d'_2c_3$  is an edge. If  $d_2$  is adjacent to  $c'_1$  or  $c_3$ , then  $G$  contains  $I_5$ , and we have the result by Case 1. Hence, we may assume that  $d_2c'_1$  and  $d_2c_3$  are non-edges. By symmetry, we may assume that  $d'_2c'_3$  and  $d'_2c_1$  are non-edges. Thus, we are in Configuration  $J_6^2$  depicted in Figure 48. Set  $\phi(a) = 1$ ,  $\phi(b_1) = \phi(c_2) = 3$ ,  $\phi(b_3) = \phi(c'_1) = \phi(c'_2) = \phi(d_2) = 2$ , and  $\phi(a) = \phi(c_1) = \phi(c_3) = \phi(c'_3) = \phi(d'_2) = 1$ . For each  $i \in [3]$ ,  $\phi^{-1}(i)$  is a stable set of  $G$  for otherwise there would be a cycle of length less than 5 or a vertex of degree more than 3. Hence  $\phi$  is a 4-z-colouring of  $J_6^2$ .

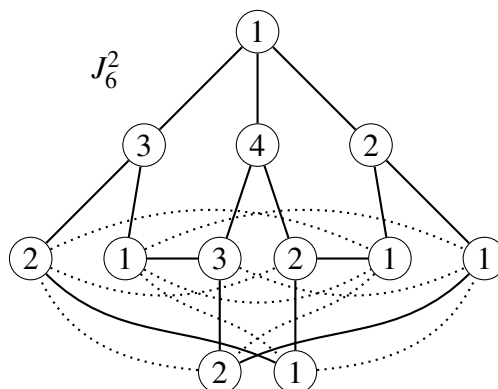

Figure 48 – The configuration  $J_6^2$  and its partial 4-z-colouring. Dotted lines represent non-edges. Some edges may be missing.

This completes Case 2.

Case 3 : Assume now that we are not in Case 1 nor 2. Then any two 5-cycles do not intersect. Let  $I_7 = (a, b_1, c_1, c_2, b_2, a)$  be a 5-cycle. Let  $b_3$  (resp.  $c'_1, c'_2, d_1$ ) be the neighbour of  $a$  (resp.  $b_1, b_2, c_1$ ) not in  $I_7$ , and let  $c_3$  and  $c'_3$  be the two neighbours of  $b_3$  distinct from  $a$ . Observe that since  $G$  has girth 5 and two 5-cycles do not intersect,  $c_1c_2$  is the unique edge in the subgraph induced by  $\{c_1, c'_1, c_2, c'_2, c_3, c'_3\}$  and  $d_1$  is not in this set. By Lemma 4.4.5,  $c_3$  has a neighbour  $d_3$  distinct from  $b_3$  which is not adjacent to  $d_1$ .

If  $d_3$  is not adjacent to  $c'_1$ , then we are in Configuration  $J_7^1$  depicted in Figure 49. Set  $\phi(a) = 4$ ,  $\phi(b_1) = \phi(c_2) = \phi(c_3) = 3$ ,  $\phi(b_3) = \phi(c_1) = \phi(c'_2) = 2$ , and  $\phi(b_2) = \phi(c'_1) = \phi(c'_3) = \phi(d_1) = \phi(d_3) = 1$ . For each  $i \in [3]$ ,  $\phi^{-1}(i)$  is a stable set of  $G$  for otherwise there would be a cycle of length less than 5. Hence  $\phi$  is a 4-z-colouring of  $J_7^1$ .

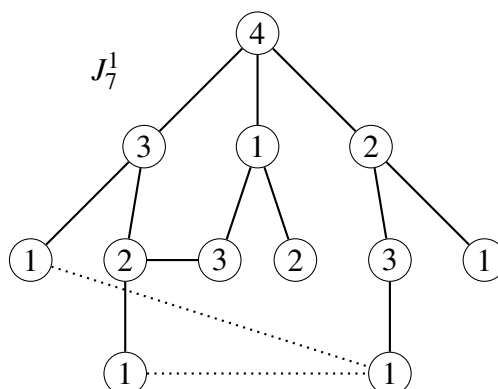

Figure 49 – The configuration  $J_7^1$  and its partial 4-z-colouring. Dotted lines represent non-edges. Some edges may be missing.

Henceforth, we may assume that  $d_3$  is adjacent to  $c'_1$ . Let  $d_2$  be the neighbour of  $c_2$  which is not in  $I_7$ . We are in Configuration  $J_7^2$  depicted in Figure 50. Set  $\phi(a) = 4$ ,

$\phi(b_2) = \phi(c_1) = \phi(c_3) = 3$ ,  $\phi(b_1) = \phi(c_2) = \phi(c'_3) = \phi(d_2) = 2$ , and  $\phi(b_3) = \phi(c'_1) = \phi(c'_2) = \phi(d_1) = \phi(d_2) = 1$ . For each  $i \in [3]$ ,  $\phi^{-1}(i)$  is a stable set of  $G$  for otherwise there would be a cycle of length less than 5 or two intersecting 5-cycles. Hence  $\phi$  is a 4-z-colouring of  $J_7^1$ .

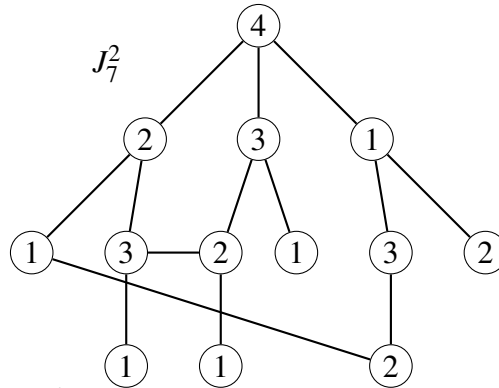

Figure 50 – The configuration  $J_7^2$  and its partial 4-z-colouring. Dotted lines represent non-edges. Some edges may be missing.

This completes Case 3 and the proof. □

**Theorem 4.4.8.** *Let  $G$  be a cubic graph of girth 3 with no induced 4-cycle. Then  $z(G) = 4$ .*

*Proof.* As in the proofs of the two previous theorems, we shall exhibit an induced subgraph of  $G$  and 4-z-colouring of it, which is sufficient according to Lemma 4.4.10.

Case 1: Assume first that  $G$  contains a diamond  $D$  as depicted in Figure 51a as a subgraph. If  $D$  is not induced in  $G$ , then  $G$  contains a complete graph on four vertices  $K_4$  whose z-chromatic number is 4. Henceforth we assume that  $D$  is an induced subgraph of  $G$ . Let  $c_i$  be the neighbour of  $b_i$  which is not in  $D$ , for  $i \in [2]$ . Then, we are in configuration  $D^1$ . Set  $\phi(a) = 4, \phi(c) = 3, \phi(b_2) = \phi(c_1) = 2$  and  $\phi(b_1) = \phi(c_2) = 1$ . For each  $i \in [2]$ ,  $\phi^{-1}(i)$  is a stable set of  $G$  for otherwise there would be a cycle of length 4. See Figure 51b. Hence  $\phi$  is a 4-z-colouring of  $D^1$ .

Case 2: Assume that  $G$  has no diamond as a subgraph. Let  $C = (a, b, c, a)$  be a 3-cycle in  $G$  and let  $d$  be the neighbour of  $a$  which is not in  $C$ . Observe that  $d$  is not adjacent to  $b$  or  $c$  because  $G$  has no diamond. Let  $b'$  and  $c'$  be, respectively, the neighbours of  $b$  and  $c$  which are not in  $C$ . As  $G$  has no induced 4-cycle,  $b'$  and  $c'$  are not adjacent and furthermore  $d$  is not adjacent to  $b'$  or  $c'$ . Let  $d'_1$  and  $d'_2$  be the neighbours of  $d$  different from  $a$ . Hence  $G$  contains the configuration  $H_1$  depicted in Figure 52 as a subgraph.

For the following subcases let  $L = \{b', c'\}$  and  $R = \{d'_1, d'_2\}$ .

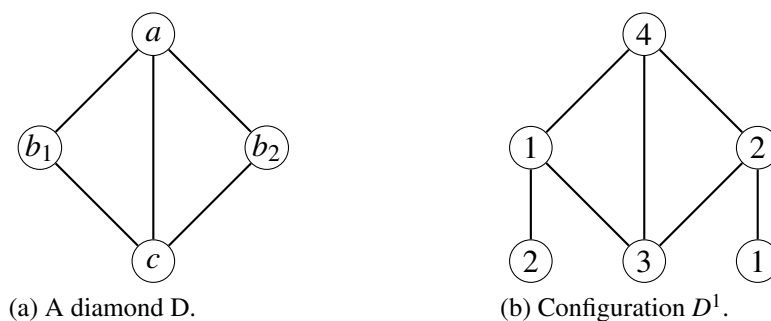

Figure 51 – The graph  $D$  and the configuration  $D^1$  and its 4-z-colouring.

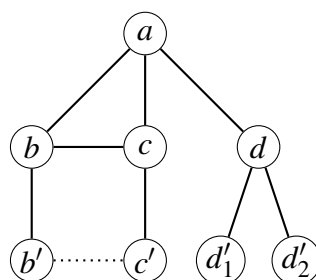

Figure 52 – The graph  $H_1$ .

Subcase 2.1 : Assume there is an edge  $uv \in E(G)$  where  $u \in L$  and  $v \in R$ . By symmetry, we may suppose that  $u = c'$  and  $v = d'_1$ .

Assume first that  $d'_1$  and  $d'_2$  are adjacent. Then we are in the configuration  $H_1^1$  depicted in Figure 53. Set  $\phi(a) = 4, \phi(c) = \phi(d'_2) = 3, \phi(d) = \phi(b') = \phi(c') = 2, \phi(b) = \phi(d'_1) = 1$ . Then  $\phi$  is a 4-z-colouring of  $H_1^1$ .

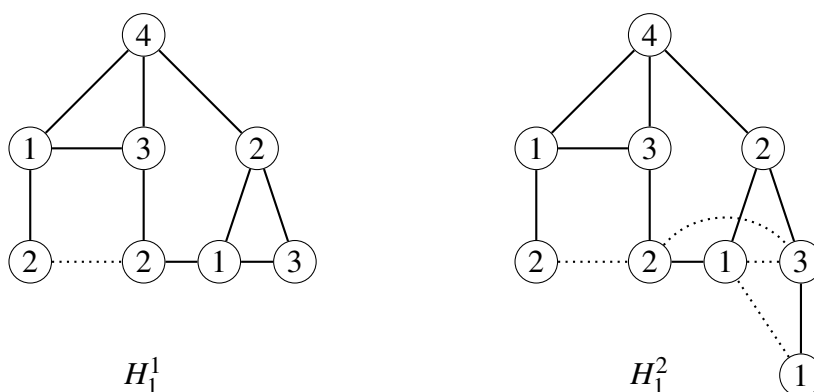

Figure 53 – The configurations  $H_1^1$  and  $H_1^2$  and their 4-z-colourings.

Assume now that  $d'_1$  and  $d'_2$  are not adjacent. Note that  $c'$  and  $d'_2$  are also not adjacent, for otherwise  $\{c', d'_1, d, d'_2\}$  would induce a 4-cycle. This implies that  $d'_2$  has a neighbour  $f$  which is not in  $H_1^1$ . The vertex  $f$  is not adjacent to  $d'_1$ , for otherwise  $\{d'_1, d, d'_2, f\}$  would induce a 4-cycle. Hence we are in Configuration  $H_1^2$  depicted in Figure 53. Set  $\phi(a) = 4, \phi(c) = \phi(d'_2) = 3,$



$\phi(d) = \phi(b') = \phi(c') = 2, \phi(b) = \phi(d'_1) = \phi(f) = 1$ . Then  $\phi$  is a 4-z-colouring of  $H_1^2$ .

Subcase 2.2 : There is no edge between  $L$  and  $R$ .

Assume first that there is a vertex  $f$  with a neighbour in  $L$  and a neighbour in  $R$ . By symmetry, we may assume that  $f$  is adjacent to  $d'_1$  and  $c'$ . This implies that  $f$  is not adjacent to  $d'_2$  because  $G$  contains no induced 4-cycle and no diamond. Hence we are in Configuration  $H_1^3$  depicted in Figure 54. Set  $\phi(a) = 4, \phi(c) = \phi(d'_1) = 3, \phi(d) = \phi(b') = \phi(c') = 2$ , and  $\phi(b) = \phi(d'_2) = \phi(f) = 1$ . Then  $\phi$  is a 4-z-colouring of  $H_1^3$ .

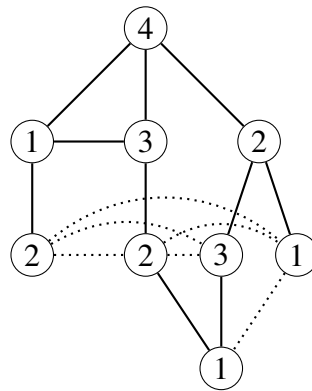

Figure 54 – Configuration  $H_1^3$ .

Henceforth we may assume that the vertices of  $L$  have no common neighbour with the vertices of  $R$ . Let  $f$  be a neighbour of  $d'_1$  that is not in  $H_1$ . Remark that  $f$  is not adjacent to  $d'_2$ . The two neighbours of  $c'$  distinct from  $c$  are not both adjacent to  $f$ , for otherwise along with  $c'$  and  $f$ , they would induce either 4-cycle or a diamond. Therefore,  $c'$  has a neighbour  $g$  distinct from  $c$  which is not adjacent to  $f$ . Hence we are in Configuration  $H_1^4$  depicted in Figure 55. Set  $\phi(a) = 4, \phi(c) = \phi(d'_1) = 3, \phi(d) = \phi(b') = \phi(c') = 2$ , and  $\phi(b) = \phi(d'_2) = \phi(f) = \phi(g) = 1$ . Then  $\phi$  is a 4-z-colouring of  $H_1^4$ .

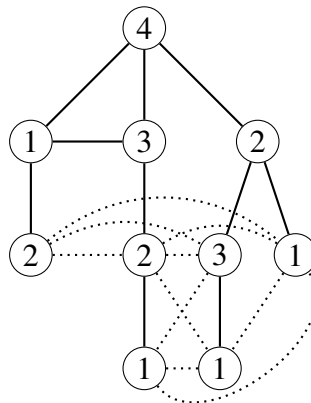

Figure 55 – Configuration  $H_1^4$ .

□

As a cubic graph with no induced  $C_4$  has girth 3 or at least 5, Theorems 4.4.6, 4.4.7, and 4.4.8 immediately imply Theorem 4.4.4.

A direct consequence of Theorem 4.4.4 is that it is polynomial to decide whether a cubic graph  $G$  have z-number and b-Grundy number 4.

**Corollary 4.4.9.** *Let  $G$  be a cubic graph. There is a polynomial time algorithm to check whether  $z(G) = \Gamma_b(G) = 4$ .*

Using atoms we can generalize this result and decide in polynomial-time whether the z-number (resp. b-Grundy number) of a  $k$ -regular graph is  $k + 1$  (Corollary 4.4.12).

**Lemma 4.4.10.** *Let  $G$  be a  $k$ -regular graph. If  $G$  has an induced subgraph  $H$  such that  $z(H) = k + 1$  (resp.  $\Gamma_b(H) = k + 1$ ), then  $z(G) = k + 1$  (resp.  $\Gamma_b(G) = k + 1$ ).*

*Proof.* Since  $G$  is  $k$ -regular, then every greedy  $(k + 1)$ -colouring  $\phi$  of a subgraph  $H$  can be greedily extended into a greedy  $(k + 1)$ -colouring  $\psi$  of  $G$ . Moreover, if  $\phi$  is a z-colouring (resp. a  $b$ -greedy colouring), then  $\psi$  is also a z-colouring (resp. a  $b$ -greedy colouring), because the  $b$ -vertices for  $\phi$  remain  $b$ -vertices for  $\psi$ . □

**Corollary 4.4.11.** *Let  $G$  be a  $k$ -regular graph.*

- (i)  $z(G) = k + 1$  if and only if  $G$  contains a  $k$ -z-atom.
- (ii)  $\Gamma_b(G) = k + 1$  if and only if  $G$  contains a  $b$ -greedy  $k$ -atom.

**Corollary 4.4.12.** *Let  $k$  be a fixed integer. Deciding whether the z-number (resp. b-Grundy number) of a given  $k$ -regular graph is  $k + 1$  is polynomial-time solvable.*

*Proof.* Given a  $k$ -regular graph, deciding whether  $z(G) = k + 1$  is equivalent to decide whether  $G$  has a  $k$ -z-atom by Corollary 4.4.11. But, by Lemma 4.3.2, there is a finite number of z-atoms, all of size at most  $a_k = (k - 3)2^{k-1} + k + 2$ . Hence one can check in time  $O(|V(G)|^{a_k})$  whether  $G$  contains a  $k$ -z-atom.

The proof for the b-Grundy number is similar using Lemma 4.3.3 instead of Lemma 4.3.2.

□

An approach towards Conjecture 4.4.2 is through the girth. It is not difficult to prove that  $d$ -regular graphs with sufficiently high girth have z-number  $d + 1$ .

**Proposition 4.4.13.** *If  $G$  is a  $k$ -regular graph with girth at least  $2k + 4$ , then  $z(G) = k + 1$ .*

*Proof.* Zaker (2020) shows that there is a tree  $R_k$  such that, for every tree  $T$ ,  $z(T) \geq k$  if and only if  $T$  contains a subtree isomorphic to  $R_k$ . The tree  $R_k$  has maximum degree  $k - 1$  and diameter at most  $2k + 2$ . Let  $G$  be a  $k$ -regular graph with girth at least  $2k + 4$ . Let  $v$  be a vertex of  $G$ . The subgraph induced by the set of vertices of distance at most  $k + 2$  from  $v$  contains a complete  $k$ -ary tree rooted at  $v$  of depth  $k + 2$ . But the tree  $R_{k+1}$  has maximum degree  $k$  and diameter at most  $2k + 4$  and is contained in such a tree. Hence  $G$  contains  $R_{k+1}$  as an induced subgraph. Now  $R_{k+1}$  admits a  $(k + 1)$ -z-colouring, which can be greedily extended into a  $(k + 1)$ -z-colouring of  $G$ . Hence  $z(G) \geq k + 1 = \Delta(G) + 1 \geq z(G)$ .  $\square$

#### 4.5 b-greedy and z-colourings in Trees

In this section, we study z-colourings and b-greedy colourings of trees. We first answer Problem 4.1.8 (page 82) for trees by showing that all trees are both z-continuous and  $\Gamma_b$ -continuous. We then consider Problem 4.1.11 (page 83) restricted to trees. Zaker (2020) proved that  $\Gamma(T) \leq z(T)^2$  for every tree  $T$ . We improve this bound by showing that  $\Gamma(T) \leq 2z(T) - 2$  (Corollary 4.5.6). This bound is tight up to a constant no greater than 1 (Proposition 4.5.7).

**Lemma 4.5.1.** *Let  $T$  be a tree and  $T'$  be a subtree of  $T$  and  $k \geq 2$  an integer. Every  $k$ -z-colouring (resp. b-greedy  $k$ -colouring) of  $T'$  can be extended into a  $k$ -z-colouring (resp. b-greedy  $k$ -colouring) of  $T$ .*

*Proof.* Let  $\phi$  be a  $k$ -colouring of  $T'$ . We can extend it to  $T$  as follows. For each connected component  $C$  of  $T - T'$ , let  $r$  and  $s$  be the vertices of  $C$  and  $T'$  respectively which are adjacent. Colour the vertices of  $C$  with colour 1 and 2 so that  $r$  gets a colour different from  $\phi(s)$ .

Observe that if  $\phi$  was a  $k$ -z-colouring (resp. b-greedy  $k$ -colouring) of  $T'$  then the resulting colouring is a  $k$ -z-colouring (resp. b-greedy  $k$ -colouring) of  $T$  with  $k$  colours.  $\square$

**Theorem 4.5.2.** *Every tree is z-continuous.*

*Proof.* Let  $T$  be a tree. Set  $p = z(T)$ , and let  $\phi$  be a  $p$ -z-colouring of  $T$  with b-vertices  $b_1, \dots, b_p$ . By definition of z-colouring,  $b_p$  is adjacent to every  $b_i$ ,  $i \in [p - 1]$ .

Let  $2 \leq q < p$ . For each  $i$ , let  $A_i$  be the connected component of  $b_i$  in the subgraph of  $T$  induced by the vertices of colour less than  $q$ . Let  $T'$  be the subtree of  $T$  induced by  $\{b_p\} \cup \bigcup_{i \in [q-1]} V(A_i)$  and let  $\phi'$  be the colouring of  $T'$  such that  $\phi'(v) = \phi(v)$  if  $v \in \bigcup_{i \in [q-1]} V(A_i)$ , and

$\phi(b_p) = q$ . One easily checks that  $\phi'$  is a  $q$ -z-colouring of  $T'$ . Thus, by Lemma 4.5.1,  $T$  admits a  $q$ -z-colouring.

Therefore,  $T$  is z-continuous. □

Although a z-colouring is also a b-greedy colouring, the above result does not imply that trees are  $\Gamma_b$ -continuous because the b-Grundy number of a tree can be larger than its z-number. So, Theorem 4.5.2 only covers a portion of the  $\Gamma_b$ -spectrum. As a matter of fact, by Proposition 4.5.7, it could cover at most half of the  $\Gamma_b$ -spectrum. Therefore we have the following.

**Theorem 4.5.3.** *Every tree is  $\Gamma_b$ -continuous.*

*Proof.* Let  $T$  be a tree. Set  $p = \Gamma_b(T)$ , and let  $\phi$  be a b-greedy  $p$ -colouring of  $T$ .

Let  $2 \leq q < p$ . Let  $F'$  be the subgraph of  $T$  induced by the vertices with colour in  $[q]$ . We claim that  $\phi$  is a b-greedy  $q$ -colouring of  $F'$ . Indeed, for  $i \in [q]$ , consider a b-vertex  $b_i$  of colour  $i$  of  $T$ . Because of its colour,  $b_i$  is in  $F'$  and it is also a b-vertex of this  $q$ -colouring since all its neighbours of colour at most  $q$  are in  $F'$  too. Similarly, in this  $q$ -colouring every vertex of  $F'$  is greedy.

We now to extend greedily this colouring into a  $q$ -colouring of  $T$  as follows: as long as there is an uncoloured vertex  $v$  of  $T$  which is adjacent to at least one already coloured vertex, we colour  $v$  with the smallest integer in  $[q]$  not assigned to a neighbour of  $v$  if such an integer exists, and we stop if there is no such integer.

If this procedure manages to colour all vertices, then the resulting colouring is a b-greedy colouring of  $T$ . Otherwise, the procedure stopped at some vertex  $v$  which has neighbours coloured with every colour in  $[q]$ . Let  $u_1, u_2, \dots, u_k$  be neighbours of  $v$  already of colour  $q$ .

For all  $i \in [q]$ , let  $C_i$  be the connected component containing  $u_i$  in the subgraph  $F$  of  $T$  induced by the already coloured vertices. Since  $C_i$  is a tree, we can recolour all its vertices with 1 and 2, but if we do this for each  $C_i$  we may lose all b-vertices of some colour. If we can recolour  $C_i$  with 1 and 2 without losing all b-vertices of some colour, we do. Otherwise, for some  $j \in [q]$ , there is a colour  $\ell$  such that all the b-vertices of colour  $\ell$  are in  $C_j$ . Our goal now is to recolour the vertex  $u_j$  so that later we can colour  $v$  with  $q$ . There are at least  $q - 1$  components in  $C_j - u_j$  if each has a b-vertex of a distinct colour, then  $C_j$  have b-vertices of all colours and, by Lemma 4.5.1, we can extend the colouring of  $C_j$  to a  $q$ -colouring of  $T$ . Then, we may assume that there is a component of  $C_j - u_j$  that we can recolour with 1 and 2 without losing any b-vertex

except possible  $u_j$ . We repeat this step until there is a colour  $r \in [q - 2]$  available for recolouring  $u_j$ .

In this point, we recoloured all vertices  $u_1, u_2, \dots, u_k$  with colours in  $[q - 2]$ , then we colour  $v$  with  $q$  and proceed extending this b-greedy colouring to the remaining vertices as before.  $\square$

The **binomial trees**  $B_k$ ,  $k \in \mathbb{N}$ , are defined inductively as follows. The 1-binomial tree  $B_1$  is the graph with one vertex and no edges; its root is its vertex. For every  $k > 1$ ,  $k$ -binomial tree  $B_k$  is obtained from the disjoint union of  $B_1, \dots, B_{k-1}$  by adding a new vertex  $r$  linked to the roots of those trees; the new vertex  $r$  is the root of  $B_k$ . See Figure 56 for some examples. Note that  $|V(B_k)| = 2^{k-1}$ .

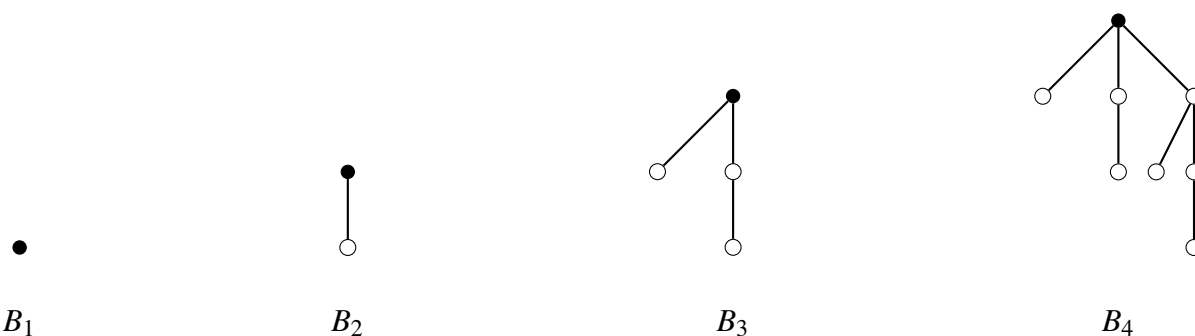

Figure 56 – The  $k$ -binomial trees for  $k \in [4]$ . The black vertices are their roots.

Binomial trees play an important role in greedy colouring of trees as shown by Beyer et al. (BEYER *et al.*, 1982).

**Lemma 4.5.4** (Beyer et al. (BEYER *et al.*, 1982)). *A tree has Grundy number at least  $k$  if and only if it contains the  $k$ -binomial tree  $B_k$  as a subtree.*

This implies that  $B_k$  is the minimum tree with Grundy number at least  $k$ . It is also true that the Grundy number of  $B_k$  cannot be larger than  $k$  because  $\Delta(B_k) = k - 1$ , so we have that  $\Gamma(B_k) = k$ .

**Proposition 4.5.5.**  $z(B_k) = \lfloor k/2 \rfloor + 1$ .

*Proof.* Observe that any vertex  $v \in V(B_k)$  has one neighbour of degree  $i$  for every  $i \in [d(v) - 1]$  and another neighbour with degree at least  $d(v)$ . Then, for  $j \in [d(v)]$ ,  $v$  has  $d(v) - (j - 1)$  neighbours of degree at least  $j$  and  $\max\{j \mid d(v) - (j - 1) \geq j\} = \lceil d(v)/2 \rceil$ . Thus,  $m_z(B_k) = \lceil \Delta(B_k)/2 \rceil = \lceil (k - 1)/2 \rceil = \lfloor k/2 \rfloor$ . Consequently, by Lemma 4.1.12,  $z(B_k) \leq \lfloor k/2 \rfloor + 1$ .

We can easily obtain a  $z$ -colouring of  $B_k$  with  $p = \lfloor k/2 \rfloor + 1$  colours as follows. Assign the colour  $p$  to the root  $r$  of  $B_k$  and assign the colours  $1, 2, \dots, p - 1$  to the neighbours of  $r$  with degree  $k - 1, k - 2, \dots, p - 1$  respectively. By construction, the vertex  $v_i$  of colour  $i$ , for  $i \in [p - 1]$ , is the root of a subtree that contains  $B_{p-1}$  and then we can greedily colour the remaining vertices in order to make  $v_i$  a  $b$ -vertex of colour  $i$ . This implies that  $z(B_k) \geq \lfloor k/2 \rfloor + 1$ .

Therefore  $z(B_k) = \lfloor k/2 \rfloor + 1$ . □

**Corollary 4.5.6.** *If  $T$  is a tree, then  $z(T) \geq \lceil \Gamma(T)/2 \rceil + 1$ . Thus  $\Gamma_b(T) \leq \Gamma(T) \leq 2z(T) - 2$ .*

*Proof.* Let  $T$  be a tree, and let  $k = \Gamma(T)$ . Then, by Lemma 4.5.4,  $T$  contains the  $k$ -binomial tree  $B_k$ . Hence, by Lemma 4.5.1 and Proposition 4.5.5,  $z(T) \geq z(B_k) = \lfloor k/2 \rfloor + 1$ . Hence  $\Gamma_b(T) \leq \Gamma(T) \leq 2z(T) - 2$ . □

This corollary is tight up to the rounding as shown by the following proposition.

**Proposition 4.5.7.** *For every  $k \geq 4$ , there is a tree  $T_k$  such that  $\Gamma_b(T_k) = k$  and  $z(T_k) \in \{\lfloor k/2 \rfloor + 1, \lfloor k/2 \rfloor + 2\}$ .*

*Proof.* Given a copy of  $B_k$  and a integer  $i \in [k]$ , let  $v_i$  be the neighbour of the root of  $B_k$  that has degree  $i - 1$  and let  $B_k^{-i}$  be the tree obtained from  $B_k$  by removing  $v_i$  and the vertices of the  $B_i$  rooted on  $v_i$ . For  $i \in [k - 2]$  we define  $F_k^i$  as the tree constructed as follows: for  $j \in [i - 1], \ell \in \{i + 1, \dots, k\}$ , we add the vertex  $r_i$  and copy a of  $B_j$  with root  $v_j^i$  and a copy of  $B_\ell^{-i}$  with root  $v_\ell^i$  along with the edges  $r_i v_j^i, r_i v_\ell^i$ .

Now we are ready for constructing  $T_k$ . We start by adding a copy of  $F_k^i$ , for every  $i \in [k - 2]$ . Then, for  $j \in [k - 3]$ , we connect  $F_k^j$  with  $F_k^{j+1}$  by identifying the leaf (vertex of degree 1) adjacent to  $r_{j+1}$  with the leaf of  $F_k^j$  that is the most distant from  $r_j$  (at distance  $k - 1$ ).

See Figure 57.

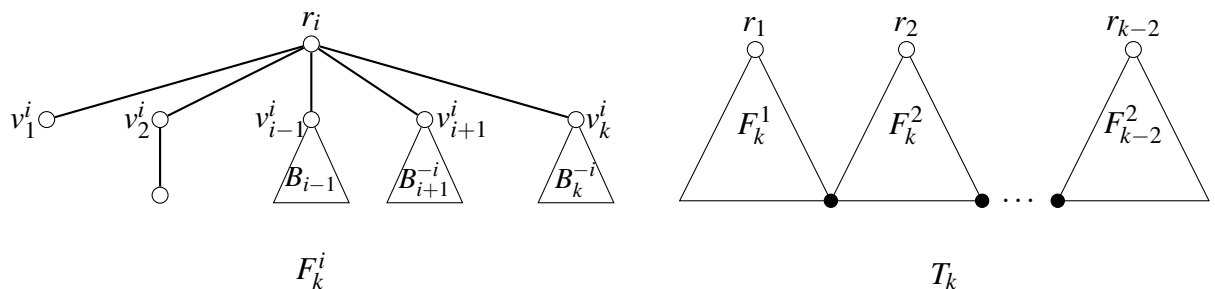

Figure 57 – Representation of  $F_k^i$  and  $T_k$ . The black vertices represent the leaves of  $F_k^i$  and  $F_k^{i+1}$  that are identified, for  $i \in [k - 3]$ .

**Claim 4.5.7.1.**  $\Gamma_b(T_k) = k$ .

*Proof.* Note that  $\Delta(T_k) = k - 1$  so  $\Gamma_b(T_k) \leq k$ . We now construct a b-greedy colouring  $c$  of  $T_k$  with exactly  $k$  colours. Set  $c(r_i) = i$ , for every  $i \in [k - 2]$ . Observe that either  $v_j^i$  is a root of a  $B_j$  in  $F_k^i$  that we can greedily colour in such a way that  $c(v_j^i) = j$  or  $v_j^i$  is the root of a  $B_k^{-i}$  that we can also greedily colour in order to make  $c(v_j^i) = j$  because  $v_j^i$  is neighbour of  $r_i$  which already has colour  $i$ . Then, we proceed the colouring by making  $c(v_j^1) = j$ , for  $j \in \{2, \dots, k\}$ , and colouring the remaining vertices of  $F_k^1$  following the previous observation. As  $v_1^2$  is a vertex of degree 1 in  $F_k^1$ , and it is not adjacent to  $r_1$ , it was greedily coloured with colour 1, and so we can proceed colouring  $F_k^2, F_k^3, \dots, F_k^{k-2}$  likewise. We point out that, for every  $i \in [k - 2]$ , vertex  $r_i$  is a b-vertex of colour  $i$ . Moreover,  $v_k^i$  is a b-vertex of colour  $k$  because  $c$  is greedy and  $v_k^i$  has a neighbour of colour  $k - 1$  which is also a b-vertex. Thus,  $c$  is a b-greedy colouring and therefore  $\Gamma_b(T_k) = k$ .  $\diamond$

**Claim 4.5.7.2.**  $z(T_k) \in \{\lceil k/2 \rceil + 1, \lfloor k/2 \rfloor + 2\}$ .

*Proof.* We shall first prove that  $m_z(T_k) \leq \lfloor k/2 \rfloor + 1$ , which by Lemma 4.1.12, implies  $z(T_k) \leq \lfloor k/2 \rfloor + 2$ .

Assume for a contradiction that  $m_z(T_k) \geq \lfloor k/2 \rfloor + 2$ . Then there is a vertex  $v \in V(T_k)$  with  $\lfloor k/2 \rfloor + 2$  neighbours, all with degree at least  $\lfloor k/2 \rfloor + 2$ . For  $i \in [k - 2]$ ,  $r_i$  has exactly one neighbour of degree  $j$ , for  $j \in [k - 1]$ , so at most  $\lceil (k - 1)/2 \rceil - 1 = \lfloor k/2 \rfloor - 1$  neighbours with degree at least  $\lfloor k/2 \rfloor + 2$  and therefore  $v \neq r_i$ . Similarly,  $v \neq v_j^i$  for  $j \in [k - 1] \setminus \{i\}$ , because  $v_j^i$  has  $\lfloor j/2 \rfloor + 1$  neighbours with degree at least  $\lfloor j/2 \rfloor + 2$  if  $j < i$  and only  $\lfloor j/2 \rfloor$  such neighbours if  $j > i$ . Finally, any other vertex  $w$  and its neighbours are all contained in a  $k$ -binomial tree and  $m_z(B_k) = \lfloor k/2 \rfloor$  so  $v \neq w$ . This is a contradiction.

Set  $p = \lceil k/2 \rceil + 1$ . Let us describe a z-colouring  $c$  with  $p$  colours. We give to the vertex  $v_k^1$  the colour  $p$  and we set  $c(r_1) = 1$ . Now let  $w_1 = r_1$  and let  $w_2, w_3, \dots, w_{p-1}$  be the neighbours of  $v_k^1$  with the respective degrees  $k - 1, k - 2, \dots, k - (p - 2)$  that were not coloured yet. We give the  $p - 2$  remaining colours  $2, 3, \dots, p - 1$  to the vertices  $w_2, w_3, \dots, w_{p-1}$  in this order. As  $w_i$  is a root of a subtree  $W_i$  that contains  $B_{p-1}$ , we can greedily colour  $W_i$  in such a way that  $w_i$  becomes a b-vertex of colour  $i$ . To conclude, we colour the other vertices of  $T_k$  using the colours 1 and 2, which is possible because  $T_k$  is bipartite. As  $v_k^1$  is neighbour of a b-vertex of colour  $i$  for every  $i \in [p - 1]$ , we have that  $c$  is a z-colouring.  $\diamond$

□

To close this section we consider the complexity of computing the b-Grundy number and the z-number of trees. Lemma 4.3.2 (page 89), Lemma 4.3.3 (page 89) and Lemma 4.5.1 imply the following which the restriction to the z-number was already in (ZAKER, 2020):

**Corollary 4.5.8.** *For any fixed  $k$ , deciding whether a given tree  $T$  has b-Grundy number (resp. z-number) at least  $k$  can be done in polynomial time.*

*Proof.* We give the proof for the b-Grundy number. It is identical for the z-number. By definition of b-greedy  $k$ -atom and Lemma 4.5.1, a tree has b-Grundy number at least  $k$  if and only if it contains a b-greedy  $k$ -atom. But, by Lemma 4.3.3, there is a finite number of b-greedy  $k$ -atoms. Thus, checking whether  $T$  contains a b-greedy  $k$ -atoms can be done in  $O(|T|^s)$  with  $s$  the maximum order of a b-greedy  $k$ -atom. □

When  $k$  is not fixed, there is no direct implication, as potentially there is a huge number of atoms. However, Zaker (ZAKER, 2020) showed that a tree has z-number at least  $k$  if and only if it contains a particular tree  $R_k$ . This tree  $R_k$  is the unique  $k$ -z-atom of order  $(k-3)2^{k-1} + k + 2$  (see Figure 58 for examples of  $R_k$ ). This implies that computing the z-number of a tree can be done in polynomial-time.

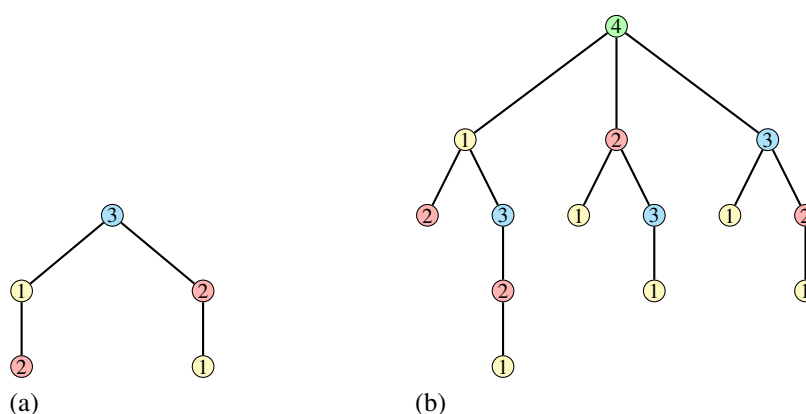

Figure 58 – The trees  $R_3$  (a) and  $R_4$  (b) with a 3-z-colouring and a 4-z-colouring, respectively. (Adapted from (ZAKER, 2020).)

We conjecture that the same holds for the b-Grundy number.

**Conjecture 4.5.9.** *Computing the b-Grundy number of a tree can be done in polynomial time.*



There are many different  $b$ -greedy  $k$ -atoms that can be contained in a tree. Let us call them  **$b$ -greedy  $k$ -forest-atoms** because they are forests. We believe that their number is bounded by a single exponential in  $k$ .

**Conjecture 4.5.10.** *There exists  $\Lambda$  such that, for each positive integer  $k$ , the number of  $b$ -greedy  $k$ -forest-atoms is at most  $\Lambda^k$ .*

This would imply Conjecture 4.5.9. Indeed consider a tree  $T$ . If  $\Gamma_b(T) \geq k$ , then  $\Gamma(T) \geq k$  and so  $T$  contains a binomial tree  $B_k$  which has size  $2^{k-1}$ . Hence  $\Gamma_b(T) \leq \log(n) + 1$ . Thus, to compute  $\Gamma_b(T)$ , we just need to test for all  $k \in [\lfloor \log(n) \rfloor + 1]$  whether  $\Gamma_b(T) \geq k$ . But for each  $k$ , we just need to check whether one of the at most  $\Lambda^k \leq \Lambda^{\log(n)+1} \leq \Lambda n^{\log \Lambda}$   $k$ -forest-atoms is an induced subgraph of  $T$ , so in total, at most  $\Lambda n^{\log \Lambda} (\log(n) + 1)$  induced subgraph tests. Each test can be done in polynomial time, so one can compute the  $b$ -Grundy number of a tree in polynomial time.

## 5 CONCLUDING REMARKS AND OPEN PROBLEMS

In the first part of this thesis, we expanded the study of inversions to oriented graphs since, before this work, it was restricted to tournaments. We considered the inversion number as a parameter of an oriented graph and proved some basic properties such as monotonicity and some others related to its behaviour in subdigraphs. We also considered its relation with the cycle arc-transversal number, cycle transversal number and cycle packing number, respectively,  $\tau'$ ,  $\tau$ ,  $\nu$ , we showed the following bounds:  $\text{inv}(D) \leq \tau'(D)$ ,  $\text{inv}(D) \leq 2\tau(D)$  and there exists a function  $g$  such that  $\text{inv}(D) \leq g(\nu(D))$  for any oriented graph  $D$ .

In the pursue of finding an elementary proof for Theorem 3.4.2, we proposed the following conjecture concerning the dijoin of oriented graphs: *for all oriented graphs  $L$  and  $R$ ,  $\text{inv}(L \rightarrow R) = \text{inv}(L) + \text{inv}(R)$  (Conjecture 3.4.4).* We were able to verify it when  $\text{inv}(L) = 1$ ,  $\text{inv}(R) = \{1, 2\}$  and when  $\text{inv}(L) = \text{inv}(R) = 2$  and both oriented graphs are strongly connected.

Regarding  $\text{inv}(n)$ , that is, the maximum inversion number of an oriented graph of order  $n$ , we proved that it is always achieved by a tournament. Then, with the aid of a computer, we obtained that  $\text{inv}(7) = \text{inv}(8) = 3$  and, for each  $n \leq 8$ , we obtained the number of unlabelled tournaments for each value of inversion number in  $\{0, \dots, \text{inv}(n)\}$ .

We also considered the complexity of deciding whether a given oriented graph has inversion number at most  $k$ . We showed that it is NP-complete when  $k = 1$  or  $k = 2$ . When restricted to tournaments, we argued that, by previous results, there is a polynomial algorithm for every fixed  $k$ . Nevertheless, this polynomial is unknown for  $k \geq 2$ . We then described explicit algorithms for  $k = 1$  and  $k = 2$ .

It is natural to ask about the complexity of computing the inversion number when restricted to oriented graphs (tournaments) for which one of these parameters is bounded. Recall that  $\text{inv}(D) = 0$  if and only if  $D$  is acyclic, so if and only if  $\tau'(D) = \tau(D) = \nu(D) = 0$ .

**Problem 5.0.1.** *Let  $k$  be a positive integer and  $\gamma$  be a parameter in  $\{\tau', \tau, \nu\}$ . What is the complexity of computing the inversion number of an oriented graph (resp. a tournament)  $D$  with  $\gamma(D) \leq k$ ?*

Conversely, it is also natural to ask about the complexity of computing any of  $\tau'$ ,  $\tau$ , and  $\nu$ , when restricted to oriented graphs with bounded inversion number. In Section 3.9.3, we

show that computing any of these parameters is NP-hard even for oriented graphs with inversion number 1. However, the question remains open when we restrict to tournaments.

**Problem 5.0.2.** *Let  $k$  be a positive integer and  $\gamma$  be a parameter in  $\{\tau', \tau, \nu\}$ . What is the complexity of computing  $\gamma(T)$  for a tournament  $D$  with  $\text{inv}(T) \leq k$ ?*

On the subject of  $b$ -greedy colourings and  $z$ -colourings, we studied their related worst case parameters  $z$  and  $\Gamma_b$ . We showed a graph  $G$  in which  $z(G) = \Gamma_b(G) = 2$  and  $\min\{\Gamma(G), \chi_b(G)\}$  is arbitrarily large. We proved that the  $z$ -number of a graph is equal to the maximum  $z$ -number of its connected components while the  $b$ -Grundy number is at least the maximum of the  $b$ -Grundy number of its components. About the spectrum of these parameters, we showed that the trees are both  $z$ -continuous and  $\Gamma_b$ -continuous, but, in general, some graphs are neither one nor the other. This still leaves open the question of which graphs, other than trees, are  $z$ -continuous or  $\Gamma_b$ -continuous (Problem 4.1.8).

As the  $z$ -number and the  $b$ -Grundy number are refinements of both the Grundy number and the  $b$ -chromatic number, for each of the numerous bounds known for  $\Gamma$  and  $\chi_b$ , it is natural to ask whether a better upper bound for  $z$  and  $\Gamma_b$  can be obtained. It is particularly interesting bounds on  $\Gamma$  and  $\chi_b$  that are functions of the chromatic number  $\chi$ . For example, one may consider **cobipartite** graphs, which are the complements of bipartite graphs. If  $G$  is cobipartite, then  $\chi_b(G) \leq \frac{4}{3}\chi(G)$ , and this bound is tight as shown by Kouider and Zaker (KOUIDER; ZAKER, 2006b). Hence, the following questions arise.

**Problem 5.0.3.** *Does there exist a constant  $\alpha < \frac{4}{3}$  such that  $\Gamma_b(G) \leq \alpha \cdot \chi(G)$  (resp.  $z(G) \leq \alpha \cdot \chi(G)$ ) for every cobipartite graph  $G$ ? Does there exist a constant  $\beta < \frac{4}{3}$  such that  $\chi_b(G) \leq \beta \cdot \Gamma_b(G)$  (resp.  $\chi_b(G) \leq \beta \cdot z(G)$ ) for every cobipartite graph  $G$ ?*

We adapted results from (HAVET; SAMPAIO, 2013) and (SAMPALIO, 2012) concerning the complexity of computing  $\gamma$  and  $\chi_b$ . We proved that it is NP-hard, and more precisely that is NP-complete to decide whether a given  $G$  satisfies  $z(G) = \Delta(G) + 1$  (resp.  $\Gamma_b(G) = \Delta(G) + 1$ ). This remains NP-complete even if  $G$  is bipartite and with either  $\Gamma(G) = \Delta(G) + 1$  or  $\chi_b(G) = \Delta(G) + 1$ . Moreover, for any two parameters  $\gamma_1$  in  $\{z, \Gamma_b\}$  and  $\gamma_2$  in  $\{\omega, \chi, \Gamma, \chi_b\}$  we showed that it is coNP-hard to decide whether  $\gamma_1(G) = \gamma_2(G)$ . In particular, when  $\gamma_2 = \chi$ , the problem is coNP-complete. We also proved the NP-hardness of deciding whether  $z(G) = \Gamma_b(G)$  for a given graph  $G$ .

For regular graphs, we conjectured (Conjecture 4.4.2) that, *except for a finite number of exceptions, all  $d$ -regular graphs with no induced 4-cycle have z-number  $d + 1$* , and we managed to prove it for  $d = 2$  and  $d = 3$ .

We also proved this conjecture for graphs with sufficient large girth. In Proposition 4.4.13, we argued that every graph  $d$ -regular with girth at least  $2d + 4$  have z-number  $d + 1$ . But we believe that the bound  $2d + 4$  is not tight. Then, it is then natural to ask the following.

**Problem 5.0.4.** *Let  $k$  be an integer greater than 1. What is the minimum integer  $g_k$  such that  $z(G) = k + 1$  for all  $k$ -regular graph  $G$  with girth at least  $g_k$ ? What is the minimum integer  $g'_k$  such that  $\Gamma_b(G) = k + 1$  for all  $k$ -regular graph  $G$  with girth at least  $g'_k$ ?*

For these two problems, we have some initial results.

In Theorem 4.4.3, we proved that 2-regular graphs without induced 4-cycle have z-number and b-Grundy number 3. This, along with the fact that the Grundy number of a 4-cycle is 2, implies the following.

**Proposition 5.0.5.**  $g_2 = g'_2 = 5$ .

The Petersen graph has girth 5 and b-chromatic number 3 and, in Theorem 4.4.6, we showed that every cubic graph with girth at least 6 has both z-number and b-Grundy number 4. Thus, we have the following.

**Proposition 5.0.6.**  $g_3 = g'_3 = 6$ .

Using atoms, we also proved that deciding whether the z-number (resp. b-Grundy number) of a given  $k$ -regular graph is  $k + 1$  is polynomial-time solvable.

Zaker (2020) proved that  $\Gamma(T) \leq z(T)^2$  for every tree  $T$ . We improved this bound to  $\Gamma(T) \leq 2z(T) - 2$ , and we also showed how to construct a tree  $T_k$  satisfying  $\Gamma_b(T_k) = k$  and  $z(T_k) \in \{\lceil k/2 \rceil + 1, \lfloor k/2 \rfloor + 2\}$  which implies that this last bound is tight up to the rounding. We argued how previous results imply that for any fixed  $k$ , deciding whether a given tree  $T$  has b-Grundy number (resp. z-number) at least  $k$  can be done in polynomial time. For the case where  $k$  is not fixed, we believe (Conjecture 4.5.9) that computing the b-Grundy number still is a polynomial problem it happens with z-number. In the latter case, (ZAKER, 2020) showed that a tree has z-number at least  $k$  if and only if it contains a particular tree  $R_k$ . In the first case, there are many different  $b$ -greedy  $k$ -atoms that can be contained in a tree, but if its number is bounded by a function of  $k$ , the problem remains polynomial.

## REFERENCES

- ALON, N. Ranking tournaments. **SIAM J. Discrete Math**, [s. l.], v. 20, p. 137–142, 2006.
- AMINE, E. S.; MEKKIA, K.; MAIDOUN, M. On the b-chromatic number of regular bounded graphs. **Discrete Applied Mathematics**, [s. l.], v. 193, p. 174 – 179, 2015. ISSN 0166-218X.
- ARAUJO, J.; SALES, C. L. On the Grundy number of graphs with few  $p_4$ 's. **Discrete Applied Mathematics**, [s. l.], Elsevier, v. 160, n. 18, p. 2514–2522, 2012.
- ASTÉ, M.; HAVET, F.; SALES, C. L. Grundy number and products of graphs. **Discrete Mathematics**, [s. l.], v. 310, n. 9, p. 1482–1490, 2010.
- BANG-JENSEN, J.; GUTIN, G. **Digraphs: Theory, algorithms and applications**. 2nd. ed. London: Springer-Verlag, 2009.
- BANG-JENSEN, J.; KRIESELL, M. On the problem of finding disjoint cycles and dicycles in a digraph. **Combinatorica**, [s. l.], v. 31, p. 639–668, 2011.
- BANG-JENSEN, J.; SILVA, J. C. F. da; HAVET, F. Inversion number of an oriented graph and related parameters. In: COUCEIRO, M.; MONNIN, P.; NAPOLI, A. (Ed.). **1st International Conference on Algebras, Graphs and Ordered Sets (ALGOS 2020)**. Nancy, France: [s.n.], 2020. (Proceedings of the 1st International Conference on Algebras, Graphs and Ordered Sets (ALGOS 2020)), p. 119–139.
- BANG-JENSEN, J.; SILVA, J. C. F. da; HAVET, F. On the inversion number of oriented graphs. **Discrete Mathematics & Theoretical Computer Science**, [s. l.], vol. 23 no. 2, special issue in honour of Maurice Pouzet, Dec. 2022.
- BANG-JENSEN, J.; THOMASSEN, C. A polynomial algorithm for the 2-path problem for semicomplete digraphs. **SIAM J. Discrete Math.**, [s. l.], v. 5, p. 366–376, 1992.
- BELKHECHINE, H. **Indécomposabilité des graphes et des tournois**. Phd Thesis (Theses) — Université Claude Bernard - Lyon I ; Université de Sfax. Faculté des sciences, Jul. 2009.
- BELKHECHINE, H.; BOUAZIZ, M.; BOUDABBOUS, I.; POUZET, M. Inversions in tournaments. *Unpublished*.
- BELKHECHINE, H.; BOUAZIZ, M.; BOUDABBOUS, I.; POUZET, M. Inversion dans les tournois. **Comptes Rendus Mathématique**, [s. l.], v. 348, n. 13, p. 703 – 707, 2010. ISSN 1631-073X.
- BEYER, T.; HEDETNIEMI, S. M.; HEDETNIEMI, S. T. A linear algorithm for the Grundy number of a tree. In: **Proceedings of the Thirteenth Southeastern Conference on Combinatorics, Graph Theory and Computing**. [S.l.: s.n.], 1982. (Utilitas Mathematica), p. 351–363.
- BONDY, J.; MURTY, U. **Graph Theory**. 1st. ed. [S.l.]: Springer Publishing Company, Incorporated, 2008. ISBN 1846289696.
- CABELLO, S.; JAKOVAC, M. On the b-chromatic number of regular graphs. **Discrete Applied Mathematics**, [s. l.], v. 159, n. 13, p. 1303 – 1310, 2011. ISSN 0166-218X.

- CAMPOS, V. A.; LIMA, C. V.; MARTINS, N. A.; SAMPAIO, L.; SANTOS, M. C.; SILVA, A. The  $b$ -chromatic index of graphs. **Discrete Mathematics**, [s. l.], Elsevier, v. 338, n. 11, p. 2072–2079, 2015.
- CHARBIT, P.; THOMASSÉ, S.; YEO, A. The minimum feedback arc set problem is NP-hard for tournaments. **Combin. Probab. Comput.**, [s. l.], v. 16, p. 1–4, 2007.
- CHRISTEN, C. A.; SELKOW, S. M. Some perfect coloring properties of graphs. **Journal of Combinatorial Theory**, [s. l.], Series B, v. 27, n. 1, p. 49–59, 1979. ISSN 0095-8956.
- CORTEEL, S.; VALENCIA-PABON, M.; VERA, J.-C. On approximating the  $b$ -chromatic number. **Discrete Applied Mathematics**, [s. l.], Elsevier, v. 146, n. 1, p. 106–110, 2005.
- DAILEY, D. P. Uniqueness of colorability and colorability of planar 4-regular graphs are NP-complete. **Discrete Mathematics**, v. 30, n. 3, p. 289–293, 1980.
- EFFANTIN, B.; KHEDDOUCI, H. The  $b$ -chromatic number of power graphs. **Discrete Mathematics and Theoretical Computer Science**, [s. l.], v. 6, n. 1, p. 45–54, 2003.
- EFFANTIN, B.; KHEDDOUCI, H. Grundy number of graphs. **Discussiones Mathematicae Graph Theory**, Uniwersytet Zielonogórski. Wydział Matematyki, Informatyki i Ekonometrii, v. 27, n. 1, p. 5–18, 2007.
- GASTINEAU, N.; KHEDDOUCI, H.; TOGNI, O. On the family of  $r$ -regular graphs with Grundy number  $r+1$ . **Discrete Mathematics**, [s. l.], v. 328, p. 5 – 15, 2014. ISSN 0012-365X.
- GOEMANS, M. X.; WILLIAMSON, D. P. Primal-dual approximation algorithms for feedback problems in planar graphs. In: CUNNINGHAM, W. H.; MCCORMICK, S. T.; QUEYRANNE, M. (Ed.). **Integer Programming and Combinatorial Optimization**. Berlin, Heidelberg: Springer Berlin Heidelberg, 1996. p. 147–161.
- HAVET, F.; IBIAPINA, A.; ROCHA, L. On the Nash number and the diminishing Grundy number of a graph. **Discrete Applied Mathematics**, [s. l.], v. 314, p. 1–16, 2022. ISSN 0166-218X.
- HAVET, F.; SAMPAIO, L. On the Grundy and  $b$ -chromatic numbers of a graph. **Algorithmica**, [s. l.], v. 65, n. 4, p. 885–899, Apr 2013. ISSN 1432-0541.
- IRVING, R. W.; MANLOVE, D. F. The  $b$ -chromatic number of a graph. **Discrete Applied Mathematics**, [s. l.], v. 91, n. 1, p. 127 – 141, 1999. ISSN 0166-218X.
- JAKOVAC, M.; KLAVŽAR, S. The  $b$ -chromatic number of cubic graphs. **Graphs and Combinatorics**, [s. l.], v. 26, n. 1, p. 107–118, Jan 2010. ISSN 1435-5914.
- JAKOVAC, M.; PETERIN, I. The  $b$ -chromatic number and related topics - a survey. **Discrete Applied Mathematics**, [s. l.], v. 235, p. 184–201, 2018. ISSN 0166-218X.
- KARP, R. M. Reducibility among combinatorial problems. In: MILLER, R. E.; THATCHER, J. W. (Ed.). **Complexity of Computer Computations**. [S.l.]: Plenum Press, 1972. p. 85–103.
- KHALEGHI, A.; ZAKER, M. More results on the  $z$ -chromatic number of graphs. **Discrete Applied Mathematics**, [s. l.], v. 338, p. 89–99, Oct 2023. ISSN 0166-218X.

KORTSARZ, G. A lower bound for approximating the Grundy number. **Discrete Mathematics & Theoretical Computer Science**, [s. l.], Episciences. org, v. 9, 2007.

KOUIDER, M.; MAHÉO, M. Some bounds for the b-chromatic number of a graph. **Discrete Mathematics**, [s. l.], Elsevier, v. 256, n. 1-2, p. 267–277, 2002.

KOUIDER, M.; ZAKER, M. Bounds for the b-chromatic number of some families of graphs. **Discrete Mathematics**, [s. l.], Elsevier, v. 306, n. 7, p. 617–623, 2006.

KOUIDER, M.; ZAKER, M. Bounds for the b-chromatic number of some families of graphs. **Discrete Mathematics**, [s. l.], v. 306, n. 7, p. 617 – 623, 2006. ISSN 0012-365X.

KRATOCHVÍL, J.; TUZA, Z.; VOIGT, M. On the b-chromatic number of graphs. In: GOOS, G.; HARTMANIS, J.; LEEUWEN, J. van; KUCERA, L. (Ed.). **Graph-Theoretic Concepts in Computer Science**. Berlin, Heidelberg: Springer Berlin Heidelberg, 2002. p. 310–320. ISBN 978-3-540-36379-8.

LEVEN, D.; GALIL, Z. NP completeness of finding the chromatic index of regular graphs. **Journal of Algorithms**, [s. l.], v. 4, n. 1, p. 35 – 44, 1983. ISSN 0196-6774.

MASIH, Z.; ZAKER, M. On Grundy and b-chromatic number of some families of graphs: A comparative study. **Graphs and Combinatorics**, [s. l.], v. 37, n. 2, p. 605–620, Mar 2021. ISSN 1435-5914.

MASIH, Z.; ZAKER, M. Some comparative results concerning the Grundy and b-chromatic number of graphs. **Discrete Applied Mathematics**, [s. l.], v. 306, p. 1–6, 2022. ISSN 0166-218X.

MCCUAIG, W. Intercyclic digraphs. In: ROBERTSON, N.; SEYMOUR, P. D. (Ed.). **Graph Structure Theory, Proceedings of a AMS-IMS-SIAM Joint Summer Research Conference on Graph Minors held June 22 to July 5, 1991, at the University of Washington, Seattle, USA**. [S.l.]: American Mathematical Society, 1991. (Contemporary Mathematics, v. 147), p. 203–245.

METZLAR, A. **Minimum transversal of cycles in intercyclic digraphs**. Phd Thesis (PhD Thesis) — University of Waterloo, Ontario, Canada, 1989.

OEIS®. **Number of outcomes of unlabeled n-team round-robin tournaments**. Accessed in February 2023. Available at: <<http://oeis.org/A000568>>.

POUZET, M.; KADDOUR, H. S.; THATTE, B. D. **On the Boolean dimension of a graph and other related parameters**. [S.l.]: arXiv, 2021.

REED, B. A.; ROBERTSON, N.; SEYMOUR, P. D.; THOMAS, R. Packing directed circuits. **Combinatorica**, [s. l.], v. 16, n. 4, p. 535–554, 1996.

REED, B. A.; SHEPHERD, F. B. The Gallai-Younger conjecture for planar graphs. **Combinatorica**, [s. l.], v. 16, n. 4, p. 555–566, 1996.

SAMPAIO, L. **Algorithmic aspects of graph colourings heuristics**. Phd Thesis (Theses) — Université Nice Sophia Antipolis, Nov. 2012.

SPECKENMEYER, E. On feedback problems in digraphs. In: **WG 1989**. [S.l.]: Springer, 1989. (Lect. Notes Comput. Sci., v. 411), p. 218–231.

TANG, Z.; WU, B.; HU, L.; ZAKER, M. More bounds for the Grundy number of graphs. **Journal of Combinatorial Optimization**, [s. l.], Springer, v. 33, p. 580–589, 2017.

ZAKER, M. Grundy chromatic number of the complement of bipartite graphs. **Australas. J Comb.**, [s. l.], Citeseer, v. 31, p. 325–330, 2005.

ZAKER, M. Results on the Grundy chromatic number of graphs. **Discrete Mathematics**, [s. l.], v. 306, n. 23, p. 3166 – 3173, 2006. ISSN 0012-365X. International Workshop on Combinatorics, Linear Algebra, and Graph Coloring.

ZAKER, M. A new vertex coloring heuristic and corresponding chromatic number. **Algorithmica**, [s. l.], v. 82, p. 2395–2414, 2020.

ZUCKERMAN, D. Linear degree extractors and the inapproximability of max clique and chromatic number. **Theory of Computing**, [s. l.], v. 3, n. 6, 2007.



**APPENDIX A – FROM BRANCHINGS TO FLOWS: A STUDY OF AN EDMONDS’  
LIKE PROPERTY TO ARC-DISJOINT BRANCHING FLOWS**

# From branchings to flows: a study of an Edmonds' like property to arc-disjoint branching flows

Cláudio Carvalho<sup>1\*</sup>      Jonas Costa<sup>1†</sup>      Raul Lopes<sup>2‡</sup>  
Ana Karolinna Maia<sup>1§</sup>      Nicolas Nisse<sup>3¶</sup>      Cláudia Linhares Sales<sup>1||</sup>

<sup>1</sup> Departamento de Computação, Universidade Federal do Ceará, Fortaleza, Brazil

<sup>2</sup> Université Paris-Dauphine, PSL University, CNRS UMR7243, LAMSADE, Paris, France

<sup>3</sup> Université Côte d'Azur, Inria, CNRS, I3S, Sophia-Antipolis, France

revisions 4<sup>th</sup> Apr. 2022, 9<sup>th</sup> Nov. 2022; accepted 10<sup>th</sup> Mar. 2023.

---

An  $s$ -branching flow  $f$  in a network  $\mathcal{N} = (D, u)$ , where  $u$  is the capacity function, is a flow that reaches every vertex in  $V(D)$  from  $s$  while loosing exactly one unit of flow in each vertex other than  $s$ . Bang-Jensen and Bessy [TCS, 2014] showed that, when every arc has capacity  $n - 1$ , a network  $\mathcal{N}$  admits  $k$  arc-disjoint  $s$ -branching flows if and only if its associated digraph  $D$  contains  $k$  arc-disjoint  $s$ -branchings. Thus, a classical result by Edmonds stating that a digraph contains  $k$  arc-disjoint  $s$ -branchings if and only if the in-degree of every set  $X \subseteq V(D) \setminus \{s\}$  is at least  $k$  also characterizes the existence of  $k$  arc-disjoint  $s$ -branching flows in those networks, suggesting that the larger the capacities are, the closer an  $s$ -branching flow is from simply being an  $s$ -branching. This observation is further implied by results by Bang-Jensen et al. [DAM, 2016] showing that there is a polynomial algorithm to find the flows (if they exist) when every arc has capacity  $n - c$ , for every fixed  $c \geq 1$ , and that such an algorithm is unlikely to exist for most other choices of the capacities. In this paper, we investigate how a property that is a natural extension of the characterization by Edmonds' relates to the existence of  $k$  arc-disjoint  $s$ -branching flows in networks. Although this property is always necessary for the existence of the flows, we show that it is not always sufficient and that it is hard to decide if the desired flows exist even if we know beforehand that the network satisfies it. On the positive side, we show that it guarantees the existence of the desired flows in some particular cases depending on the choice of the capacity function or on the structure of the underlying graph of  $D$ , for example. We remark that, in those positive cases, polynomial time algorithms to find the flows can be extracted from the constructive proofs.

**Keywords:** Digraphs, Branchings, Branching flows, Arc-disjoint flows

---

\*FUNCAP Pronem 4543945/2016.

†FUNCAP Pronem 4543945/2016, CAPES/STIC-AmSud 88881.197438/2018-01 and PhD scholarship granted by CAPES.

‡French Agence Nationale de la Recherche under contract ASSK ANR-18-CE40-0025-01. Work partially done at UFC(MDCC), with a PhD scholarship by FUNCAP.

§FUNCAP 186-155.01.00/21 and 4543945/2016 (Pronem).

¶French Agence Nationale de la Recherche under contract Digraphs ANR-19-CE48-0013-01.

||FUNCAP Pronem 4543945/2016, and CNPq project 304831/2017-4.

**APPENDIX B – DECOMPOSIÇÃO DE FLUXOS EM DIGRAFOS  
ARCO-COLORIDOS**

To be presented in ETC 2023.

# Decomposição de Fluxos em Digrafos Arco-Coloridos

Cláudio Carvalho<sup>1</sup>, Jonas Costa<sup>1</sup>, Ana Karolinna Maia<sup>1</sup>, Cláudia Linhares Sales<sup>1</sup>

<sup>1</sup>Departamento de Computação, Centro de Ciências, Universidade Federal do Ceará  
Fortaleza - CE, CEP 60440-900, Brasil.

{claudio, jonascosta}@lia.ufc.br, karolmaia@ufc.br, linhares@dc.ufc.br

**Abstract.** Let  $\mathcal{N}$  be a network over a digraph  $D$  and  $x$  be a feasible  $(s, t)$ -flow in  $\mathcal{N}$ . We say that  $x$  is  $\ell$ -splittable if it can be decomposed into up to  $\ell$  path-flows. In this paper, we consider the problem of obtaining a path decomposition in arc-coloured digraphs, such that the sum of the number of path colours is minimum. We show that, for a given flow  $x$  in a network  $\mathcal{N}$  over an arc-coloured digraph and an integer  $k$ , it is  $\mathcal{NP}$ -complete to decide whether there is a decomposition of  $x$  into paths, such that the sum of the number of colours of the paths is at most  $k$ , and we show some cases for which this can be done in polynomial time.

**Resumo.** Sejam  $\mathcal{N}$  uma rede sobre um digrafo  $D$  e  $x$  um  $(s, t)$ -fluxo viável em  $\mathcal{N}$ . Dizemos que  $x$  é  $\ell$ -divisível se ele pode ser decomposto em até  $\ell$  fluxos caminhos. Neste artigo, consideramos o problema de obter uma decomposição em caminhos em digrafos arco-coloridos, de modo que a soma do número de cores dos caminhos seja mínima. Nós mostramos que, dado fluxo  $x$  em uma rede  $\mathcal{N}$  sobre um digrafo arco-colorido e um inteiro  $k$ , é  $\mathcal{NP}$ -completo decidir se há uma decomposição de  $x$  em caminhos, tal que a soma do número de cores dos caminhos seja no máximo  $k$ , e mostramos alguns casos para os quais isso pode ser feito em tempo polinomial.

## 1. Introdução

O problema de *fluxo de multicomódites* consiste em encontrar um fluxo que satisfaça todas as demandas de cada comódite entre uma origem e um destino, respeitando as capacidades dos arcos. Em [Kleinberg 1996], foi introduzido o problema de *fluxos indivisíveis*; que pode ser visto como uma versão restrita de fluxo de multicomódites onde a demanda de cada uma destas deve ser enviada por um único caminho. O autor mostrou que esse problema compreende vários problemas  $\mathcal{NP}$ -Completos, como os de particionamento, escalonamento, empacotamento, roteamento em circuitos virtuais etc.

Em [Baier et al. 2005], foi proposta uma generalização para o problema de fluxos indivisíveis, que pode ser aplicada a uma ou mais comódites, e a demanda de cada uma destas deve ser enviada por um número restrito e possivelmente diferente de caminhos. Trata-se do problema de *fluxos divisíveis*. Problemas desse tipo acontecem, por exemplo, em redes de comunicação, onde os clientes podem demandar conexões com determinadas capacidades entre dados pares de nós. Se as capacidades demandadas são altas, fica inviável para o administrador da rede atendê-las de forma indivisível. Por outro lado, o cliente pode não querer lidar com muitas conexões de pequenas capacidades.

De acordo com [Granata et al. 2013], digrafos coloridos são usados para modelar situações onde é crucial representar diferenças qualitativas (em vez de quantitativas)

**APPENDIX C – NEW MENGER-LIKE DUALITIES IN DIGRAPHS AND  
APPLICATIONS TO HALF-INTEGRAL LINKAGES**

To be presented in ESA23.

# New Menger-like dualities in digraphs and applications to half-integral linkages

Victor Campos ✉ 

ParGO group, Universidade Federal do Ceará, Fortaleza, Brazil

Jonas Costa ✉

ParGO group, Universidade Federal do Ceará, Fortaleza, Brazil

Raul Lopes ✉ 

DIENS, École normale supérieure, CNRS, PSL University, Paris, France

Université Paris-Dauphine, CNRS UMR7243, PSL University, Paris, France

Ignasi Sau ✉ 

LIRMM, Université de Montpellier, CNRS, Montpellier, France

---

## Abstract

We present new min-max relations in digraphs between the number of paths satisfying certain conditions and the order of the corresponding cuts. We define these objects in order to capture, in the context of solving the half-integral linkage problem, the essential properties needed for reaching a large bramble of congestion two (or any other constant) from the terminal set. This strategy has been used ad-hoc in several articles, usually with lengthy technical proofs, and our objective is to abstract it to make it applicable in a simpler and unified way. We provide two proofs of the min-max relations, one consisting in applying Menger's Theorem on appropriately defined auxiliary digraphs, and an alternative simpler one using matroids, however with worse polynomial running time.

As an application, we manage to simplify and improve several results of Edwards et al. [ESA 2017] and of Giannopoulou et al. [SODA 2022] about finding half-integral linkages in digraphs. Concerning the former, besides being simpler, our proof provides an almost optimal bound on the strong connectivity of a digraph for it to be half-integrally feasible under the presence of a large bramble of congestion two (or equivalently, if the directed tree-width is large, which is the hard case). Concerning the latter, our proof uses brambles as rerouting objects instead of cylindrical grids, hence yielding much better bounds and being somehow independent of a particular topology.

We hope that our min-max relations will find further applications as, in our opinion, they are simple, robust, and versatile to be easily applicable to different types of routing problems in digraphs.

**2012 ACM Subject Classification** Mathematics of computing → Discrete mathematics → Graph theory → Graph algorithms.

**Keywords and phrases** directed graphs, min-max relation, half-integral linkage, directed disjoint paths, bramble, parameterized complexity, matroids.

**Related Version** A conference version of this article will appear in the *Proceedings of the 31st Annual European Symposium on Algorithms (ESA), LIPIcs, Amsterdam, The Netherlands, September 2023*.

**Funding** *Victor Campos*: FUNCAP/PRONEM PNE-0112-00061.01.00/16, and CAPES/Cofecub 88887.712023/2022-00.

*Jonas Costa*: FUNCAP/PRONEM PNE-0112-00061.01.00/16, FUNCAP PS1-0186-00155.01.00/2, and PhD scholarship granted by CAPES.

*Raul Lopes*: group Casino/ENS Chair on Algorithmics and Machine Learning, and French National Research Agency under JCJC program (ASSK: ANR-18-CE40-0025-01).

*Ignasi Sau*: ELIT (ANR-20-CE48-0008-01).

## INDEX

- $\Gamma_b$ -spectrum, 81
- z-spectrum, 81
- $k$ -inversion-critical tournament, 40
- $d$ -regular graph, 25
- $k$ -colourable
  - $k$ -colourable graph, 70
- $k$ -colouring, 70
- acyclic digraph, 26
- adjacent vertices, 22
- atoms, 88
  - $j$ -greedy atoms, 88
  - b-greedy  $k$ -atom, 89
  - z-atom, 89
- augmentation
  - z-augmentation, 55
- b-chromatic number, 74
- b-colouring, 73
- b-greedy  $k$ -atom, 89
- b-greedy colourings, 75
- b-Grundy number, 77
- b-improvement, 73
- b-vertex, 73
- bipartite graph, 24
- chromatic number, 70
- clique, 24, 79
  - clique number, 24
- colour classes, 70
- colouring, 70
- complete graph, 24
- connected component, 25
- connected graph, 25
- contractable
  - a contractable arc, 58
- cubic graph, 25
- cycle, 24
- cycle arc-transversal, 34
- cycle arc-transversal number, 35
- cycle packing, 38
- cycle packing number, 38
- cycle transversal, 34
- cycle transversal number, 35
- decycling family, 29
- degree
  - degree of a vertex, 23
- diameter, 25
- digon, 26
- digraph, 25
  - order, size, disjointness, disjoint union, 26
  - strongly connected, 27
- dijoin
  - dijoin of two graphs, 37
- directed cycle, 26
- directed graph, 25
- directed path, 26
- disconnected graph, 25
- distance
  - distance between vertices, 25
- end-vertices, 22

- extension
  - of an oriented graph, 31
- feedback arc set, 35
- feedback vertex set, 34
- forest, 25
- girth, 25
- graph, 22
  - complement, 24
  - connected, 25
  - diameter, 25
  - disconnected, 25
  - girth, 25
  - maximum degree, 23
  - minimum degree, 23
  - order, 22
  - simple, 22
  - size, 22
- greedy algorithm, 71
- greedy colouring, 71
- greedy improvement, 72
- Grundy number, 72
- head
  - head of an arc, 25
- in-degree, 25
- in-neighbours, 25
- incidence function, 22
- independent set, 24
- intercyclic
  - intercyclic digraph, 57
- inversion
  - the inversion operation, 28
- inversion number, 29
- isomorphic
  - isomorphic graphs, 23
- leaf, 25
- lexicographic product, 36
  - lexicographic product of digraphs, 27
- loop, 22, 25
- monotone
  - monotone parameter of a graph, 82
- neighbourhood, 22
- neighbours, 22
- nice vertex, 77
- orientation
  - orientation of a graph, 27
- oriented graph, 27, 29
- out-degree, 25
- out-neighbours, 25
- parallel arcs, 25
- parallel edges, 22
- path, 24
- regular graph, 25
- simple graph, 22
- sink, 26
- source, 26
- stable set, 24
- star
  - star of order  $n$ , 24
- strongly connected digraph, 27
- subdigraph, 26



subgraph, 23

    induced subgraph, 23

    spanning subgraph, 23

supergraph, 23

tail

    tail of an arc, 25

tournament, 27

transitive tournament, 27

tree, 25

triangle

    undirected triangle, 25

underlying graph, 27

weak

    a weak arc, 58

z-atom, 89

z-colouring, 77

z-number, 77